

Uniden[®] | **GUARDIAN**[™] 

Lullaboo G403 Baby Monitor User's Guide



CUSTOMER CARE

At Uniden®, we care about you!

If you need assistance, please do NOT return this product to your place of purchase. Our customer care specialists are available to serve you.

Quickly find answers to your questions by:

1. Reading your owner's manual, included with this product.
2. Visiting our customer support website at www.uniden.com.
3. Calling our customer care specialists at 1-817-858-2900 or 1-800-658-8068.

CONTENTS

Customer Care	2	Camera On	21
INTRODUCTION	4	Recorder Setup Screen	22
FEATURES	4	Network Setup Screen	26
GETTING STARTED	5	Alarm Setup Screen	29
Using This Manual	5	System Setup Screen	31
What's Included	5	System Upgrade	36
Getting to Know the MOnitor and Camera	6	Language	36
What the lights mean	7	Quick Tips	37
Setting Up the Equipment	7	REMOTE ACCESS	38
Set Up the Monitor	7	Overview	38
Mount the Camera Stand	8	System Requirements	38
Attach the Camera	9	Connecting to the Internet	38
Connect to Power	9	Connecting to the Intranet (Home network)	39
Setting Up Your System	9	Downloading and Using the Apps	39
Camera Settings	9	Android™	39
System Settings	9	iPhone®	42
Recording Settings	10	SOLVING PROBLEMS	44
UNIDEN GUARDIAN LULLABOO FIRMWARE OPERATION		ADDITIONAL INFORMATION	46
OVERVIEW	11	Product Specifications	46
Live Screen	11	Lithium-Polymer Battery Warning	47
What the icons Mean	12	Recycling and Disposal Information	47
Changing How the Live Screen Displays	14	FCC Compliance Information	48
Using the PentaZoom™ Feature	14	Part 15 Compliance Statement	48
Using Your System	15	RF Exposure Information	48
Recording Live Video	15	IC Compliance Information	49
Playing Back Recorded Video	15	Radio Equipment Notice	49
Adding New Cameras	16	CE Compliance Information	49
GUARDIAN LULLABOO SCREEN DESCRIPTION	18	Three-Year Limited Warranty	49
Overview	18		
Guardian Lullaboo Settings Screen	18		
Camera Setup Screen	20		
Pairing	20		

Uniden surveillance products are not manufactured and/or sold with the intent to be used for illegal purposes. Uniden expects consumer's use of these products to be in compliance with all local, state and federal law. For further information on video surveillance and audio recording legal requirements, please consult your local, state and federal law.

INTRODUCTION

FEATURES

- 2.4GHz Digital FHSS
- 4.3" high-resolution touchscreen LCD
- Easy to use graphic interface
- Secure, interference-free video
- Up to 500' wireless transmission
- Video and audio transmission
- Quad, Scan, and Full screen view
- Supports up to 4 cameras
- Infrared LEDs for night vision (up to 20')
- Built-in rechargeable Lithium Polymer battery (up to 3 hours for the camera and 3.5 hours for the monitor)
- 4GB SD card included for video recording (supports up to 32GB)
- Instant record
- Digital PentaZoom
- Remote access to live video via iPhone®/iPad® app, Android™ Smartphone/Tablet app, and PC.
- E-mail alert of motion detection

GETTING STARTED

USING THIS MANUAL

This manual is set up in six main sections:

- Getting Started. This section describes your hardware and how to physically set it up.
- Uniden Guardian™ Lullaboo Firmware Operations Overview. This section lists basic operations in an abbreviated format. It references screen details in the third section.
- Guardian Lullaboo Screen Descriptions. Here you will find detailed descriptions of each screen and how it is used.
- Remote Access. This section tells you how to connect your baby monitor to the internet and access it from your PC or other devices.
- Maintaining Your System
- Solving Problems

WHAT'S INCLUDED

You should have the following items:

- Lullaboo G403 Monitor and Cradle (1 each)
- Lullaboo G403 Camera (1)
- Lullaboo G403 Camera Stand (1)
- AC Power Adapters (2)
- Mounting Screws and Anchors
- Ethernet Cable
- SD card (4GB included; supports up to 32GB)
- Owner's Manual

***If any items are missing or damaged, contact our Customer Care Line immediately.
Never use damaged products!***

GETTING TO KNOW THE MONITOR AND CAMERA

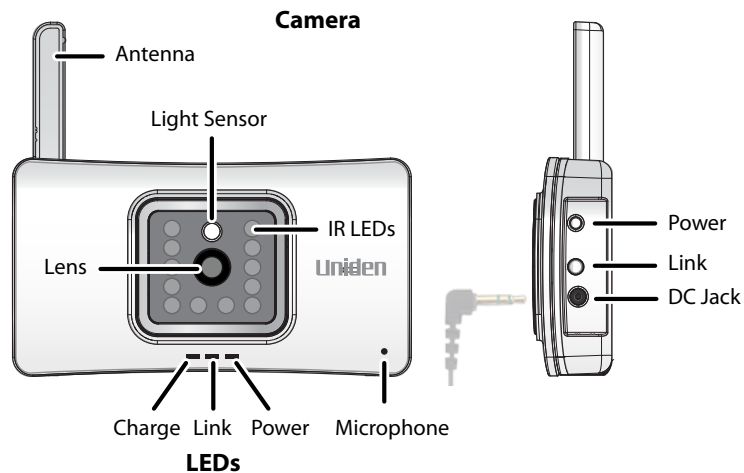
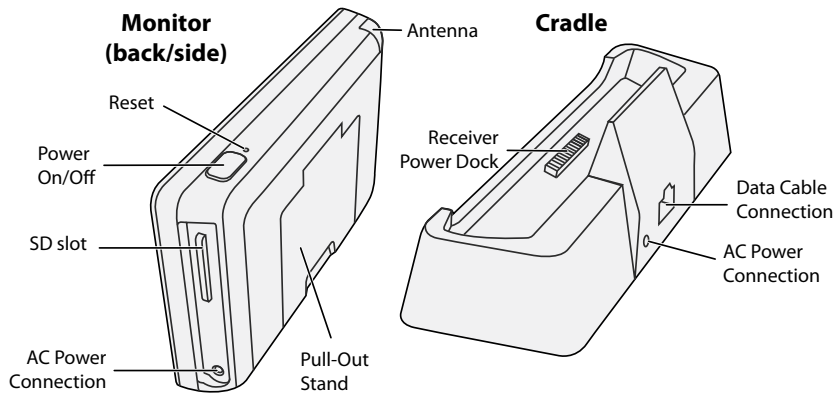

WHAT THE LIGHTS MEAN

LED	State	What it means
Power	On (Blue)	The camera is on.
	Off	The camera is off.
Link	Flashing	The camera is in pairing mode.
	On (Amber)	The camera is connected to the monitor.
	Off	The camera is in standby.
Charge	On (Green)	The battery is charging.
	Off	The battery has charged.

SETTING UP THE EQUIPMENT

SET UP THE MONITOR

1. If you are using the monitor as a stand-alone unit, flip out the stand on the back of the monitor and extend the antenna. Connect an AC adapter to the power input on the side of the monitor. If you are using the monitor in the cradle, insert the monitor into the cradle and connect an AC adapter to the input on the back of the cradle. Extend the antenna.
2. Connect the other end of the adapter to a 120 volt AC (standard indoor) power outlet.
3. Press and hold the **POWER** button on the top of the monitor for 3 - 4 seconds to power it up.
4. The monitor displays the Uniden *Welcome* screen for a few seconds and then transitions to the LIVE view.

The screen remains dark until the camera is powered up.

MOUNT THE CAMERA STAND

GENERAL GUIDELINES

The camera included with your monitor is NOT weatherproof; it is an indoor camera.

As dust, grime, and cobwebs accumulate on the camera glass, they can reflect light from the infrared LED and might lower video quality. Periodically clean the lens glass with a soft cloth.

PLACEMENT CONSIDERATIONS

Consider the following when placing a camera:

- The clearest line-of-sight between the camera and monitor is best.
 - Walls, especially brick and concrete, shorten the transmission distance.
 - Placement next to windows allows better transmission.
- Optimized motion detection range is 6 - 12 feet for the camera. The farther away an object is, the less accurate the motion detection.
- Avoid having a direct light source in view of the camera (ceiling or floor lamps, spotlights on your property or neighboring properties, street lights, etc.).

You can mount the stand on a wall, table-top, or the ceiling. If you mount the stand on the ceiling or an overhang in the house, just turn the camera right-side up once it is installed. When you are positioning the camera, you might want to bring the monitor along; it's much easier to get the camera into the right position when you have the display handy.

1. Hold the base of the camera stand where you want to mount it and mark the location of the screw holes.
2. Use the included screws and anchors to attach the base to the wall or ceiling.
3. Before attaching the camera, tug gently on the stand to make sure it is securely in place.

ATTACH THE CAMERA

Place the stand swivel mount over the camera's stand connection and slide the mount to the left until it clicks in place.

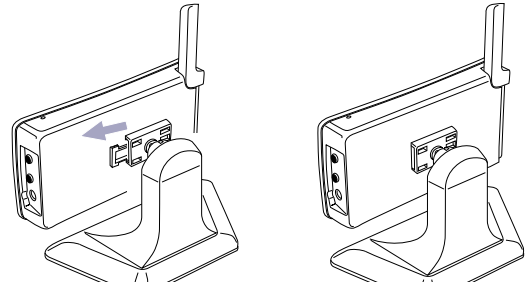

CONNECT TO POWER

1. Insert the AC adapter power plug into the camera's DC adapter input jack. Plug the other end into a 120 volt AC (standard indoor) power outlet.
2. Press **POWER** and make sure the blue power LED turns on. If it doesn't, try reconnecting the AC adapter, making sure the power outlet isn't controlled by a wall switch.

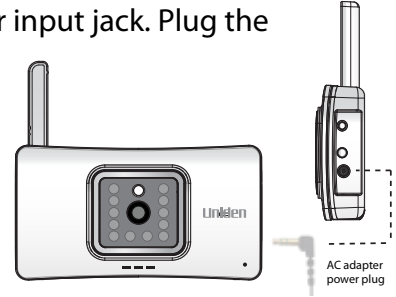

SETTING UP YOUR SYSTEM

You can now set your camera and system to your preferred settings.

CAMERA SETTINGS

- Brightness ("Guardian Lullaboo Settings Screen" on page 18)
- Motion Detection ("Guardian Lullaboo Settings Screen" on page 18)
- Schedule Recordings ("Schedule Record" on page 25)

SYSTEM SETTINGS

- Power Saving ("Power Saving" on page 31)
- Screen Auto Lock ("Screen Auto Lock" on page 32)
- Time ("Time" on page 33)
- Security code ("Security Code" on page 27)

- Language (default language is English; “Changing the Language” on page 36)

RECORDING SETTINGS

- Motion Detection (“Motion Detection” on page 22)
- Schedule Recordings (“Schedule Record” on page 25)

UNIDEN GUARDIAN LULLABOO FIRMWARE

OPERATION OVERVIEW

Your baby monitor uses Uniden Guardian Lullaboo firmware to operate a series of screens that lets you choose groups of operations. For example, when you tap on the camera icon in the Pop Up menus, you can set how you want the main viewing screen - called the *Live* screen - to display images from the paired cameras. You can scan between cameras, show all cameras on a single screen (Quad view), or only display a specific camera.





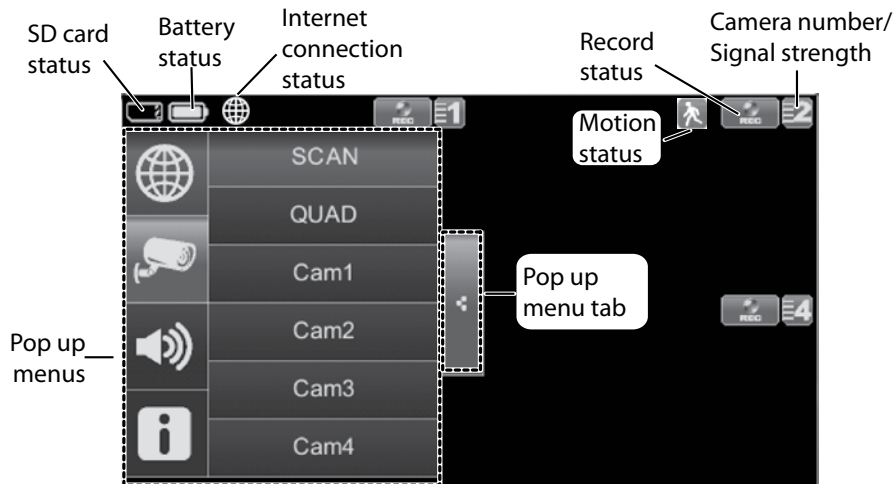

The *Live* screen lets you view the camera transmissions. It also lets you set up your screen display and make adjustments to it. Icons on the screen itself let you monitor power and camera status.









Lullaboo's firmware always defaults to the Live screen in Quad mode after being idle for 2 minutes while in any other system screen. This default ensures that the system is ready to record video even if you forget to return to the Live screen. The system can only start a recording while in Live screen mode.

LIVE SCREEN



WHAT THE ICONS MEAN

Icon	What it does
CAMERA MODE 	Select how you want the Live screen to display camera input: <ul style="list-style-type: none">• Scan between cameras (5 seconds)• Quad view (all paired cameras display)• Full view (1 camera displays on full screen)
VOLUME 	Adjust the volume level.
UNIDEN GUARDIAN LULLABOO FIRMWARE SETTINGS 	Access the Uniden Guardian Lullaboo Firmware operation screens or view recorded events.
SD CAPACITY 	Indicates memory capacity remaining.
BATTERY CAPACITY 	Displays battery capacity. This graphic shows battery at nearly full.
INTERNET/INTRANET STATUS 	Appears in Live view. Indicates connection to the internet/intranet is in progress.
	Appears in Live view and Pop Up menu. Indicates internet connection is established.

Icon	What it does
	Appears in Live view. Indicates remote viewing is in progress.
	Appears in Live view. Indicates system is not connected to the internet.
	Appears in Live view. Indicates the intranet connection is established.
CAMERA NUMBER 	Displays the camera number and signal strength through the status lines to the left of the number.
RECORD STATUS 	Tap to start or stop recording for that camera. <ul style="list-style-type: none"> • Steady on - Not recording • Flashing - Recording
MOTION 	System indicates motion detection recording in progress.
SCHEDULED 	System indicates scheduled recording in progress.
POP UP MENU TAB 	Opens and closes the Pop Up menu display.
NO SD CARD INDICATOR 	Displays red when the SD card is not present or is damaged.

CHANGING HOW THE LIVE SCREEN DISPLAYS

The Live screen displays in 2 views - Quad view or Full view. Quad view divides the screen's image area into 4 quadrants and displays camera video in each quadrant. If less than 4 cameras are on, only those cameras' video will display on the Live screen.

Full view displays a single camera's video on the entire screen. If you are in Quad view, tap on the camera quadrant you want to expand to Full view. Tap on that image to return to Quad view.



USING THE PENTAZOOM™ FEATURE

While in any camera's full screen view, selecting the + icon on the right side of the screen enables the PentaZoom feature. PentaZoom lets you select from 5 sections of the video image. Tap on a section and it will digitally zoom to full screen, focused on that section. Tap on the screen to return to Full screen mode; to go back to the PentaZoom screen, tap .



USING YOUR SYSTEM

RECORDING LIVE VIDEO

1. On the *Live* screen, tap  for the camera to begin recording.
2. Tap it again to stop recording.

You can record from all cameras at the same time.

PLAYING BACK RECORDED VIDEO

From the pop-up menus, tap the following icons as they appear on the screens:

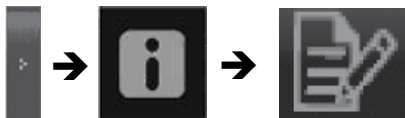

The Record List screen displays.



Record List						
2010 NOV						
SUN	MON	TUE	WED	THU	FRI	SAT
31	1	2	3	4	5	6
7	8	9	10	11	12	13
14	15	16	17	18	19	20
21	22	23	24	25	26	27
28	29	30	1	2	3	4

1. Tap on the highlighted day containing the recording you want to view or on a specific camera to only view that camera's recordings. The *Record List* screen displays those recordings listed in a folder.

If you tap on a day that is not highlighted, a folder displays with no recordings listed.

2. Tap on the recording you want to view. It displays on the screen.
3. Tap on any area of the screen that does not have control icons to bring up the playback progress bar. Tap that area again to close it.
4. While playback progress is visible, you can fast forward/rewind by dragging the playback bar forwards or backwards.
5. When playback ends, tap  to return to the *Record List*.

You can press the double arrow to move to the next or previous video.

ADDING NEW CAMERAS

Your monitor supports a total of four active cameras at a time. When you add a camera, you have to pair it to the monitor (that is, you have “introduce” the camera and monitor so they can communicate).

SOME THINGS TO KNOW ABOUT PAIRING CAMERAS

- If a camera is already assigned to the selected channel, the monitor overwrites that camera link with the new one.
- Only pair one camera at a time! The monitor links to the first camera it detects. If two or more cameras are in pairing mode, you can't control which camera the monitor will detect first.

PAIR CAMERA

1. From the *Pairing Camera* screen (see “Pairing” on page 20), tap the camera image you want to pair. A processing icon displays for a 60 second countdown.
2. During the 60 second countdown, quickly press and release the Pairing button on that camera (see “Pairing” on page 20).
3. The system automatically adjusts the *Camera On* screen accordingly.
4. If you have any trouble, consult the the table on page 17.



TROUBLESHOOTING CAMERA PAIRING

Consult the following table for camera pairing troubleshooting suggestions:

If...	Try...
the camera's signal status icon shows no bars	<ul style="list-style-type: none">• making sure the camera is plugged in and the blue LED is on.• making sure that both the camera's and the monitor's antennas are extended.• making sure the camera is paired to the correct channel.• re-pairing the camera and monitor.
the camera's signal status icon shows one or two bars or the video quality is poor	See "General Guidelines" on page 8 for tips on improving video quality.
the camera won't pair with the monitor	<ul style="list-style-type: none">• making sure the camera is plugged in and the blue LED is on.• pressing and releasing the pairing button quickly. Do not press and hold the pairing button.

GUARDIAN LULLABOO SCREEN DESCRIPTION

OVERVIEW

This section describes the Guardian Lullaboo firmware screens in detail. It provides a path to the screen being viewed.

GUARDIAN LULLABOO SETTINGS SCREEN

From the pop-up menu, tap the following icons as they appear on the screens:



This screen should display:



The Guardian Lullaboo Settings screen highlights the Camera Setup option as the default.

Main Screen	Sub Screens	What it Does
<i>Camera Setup</i>	<i>Pairing</i>	Pairs new cameras to the monitor.
	<i>Camera On</i>	Makes the cameras visible to the monitor.
	<i>Brightness</i>	Brightens or darkens the video of that camera.
<i>Recorder Setup</i>	<i>Motion Detection</i>	Records when something moves in front of the camera and continues recording for 2 minutes. Motion detection is on by default.
	<i>Email Alert</i>	Sends email notification to user's PC and/or mobile device when Motion detection senses motion in front of the camera.
	<i>Schedule Record</i>	Set up a schedule for pre-determined recording times and lengths.

Main Screen	Sub Screens	What it Does
<i>Network Setup</i>	<i>Internet Setup</i>	Select the type of internet connection to be used. (DHCP is most common.)
	<i>Security Code</i>	Set a security code for remote access.
	<i>Network Information</i>	Displays information about your network and the monitor's unique DID number.
<i>Alarm Setup</i>	<i>Period</i>	Set a length of time for the alarm to sound.
	<i>Melody</i>	Select a melody to play for the alarm.
<i>System Setup</i>	<i>Power Saving</i>	Temporarily turns off the LCD after the system is idle for 2 minutes to conserve power.
	<i>Screen Auto Lock</i>	Locks the screen from further activity until the screen is unlocked.
	<i>Time</i>	<ul style="list-style-type: none"> • Clock Alarm. Set an alarm. • Time Setting. Set the current time. • Timer. Time countdown.
	<i>Format Storage</i>	Formats/erases all the data on the SD card.
	<i>System Upgrade</i>	Upgrades the monitor firmware.
	<i>Language</i>	Changes default language setting for the monitor (English, French, or Spanish).
<i>Quick Tips</i>	NA	Provides a list of 10 common questions.

CAMERA SETUP SCREEN

PAIRING

Your camera is paired to the monitor at the factory to channel 1. When you add a new camera to your system, you have to pair it to the monitor (that is, you have “introduce” the camera and monitor so they can communicate).



SOME THINGS TO KNOW ABOUT PAIRING CAMERAS:

- If a camera is already assigned to the selected channel, the monitor overwrites that camera link with the new one.
- Only pair one camera at a time! The monitor links to the first camera it detects. If two or more cameras are in pairing mode, you can't control which camera the monitor will detect first.

From the pop-up menus, tap the following icons as they appear on the screens:

This screen should display:

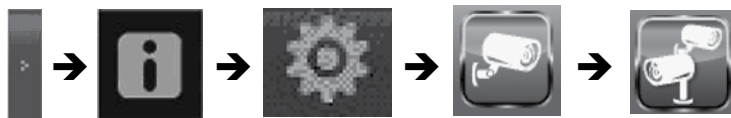

1. Tap the camera image you want to pair. A processing icon displays for a 60 second countdown.
2. Press and release **PAIRING** on the camera's side. The 60 second countdown will end when the pairing process is complete.
3. The system will automatically adjust the *Camera On* screen.

Use this procedure to move a camera from one channel to a different channel.

CAMERA ON

When you add a camera to your system, pair the camera with the monitor and the system will automatically turn it on. An X indicates a camera that is turned off; a check mark indicates the camera is turned on.

From the pop-up menu, tap the following icons as they appear on the screens:

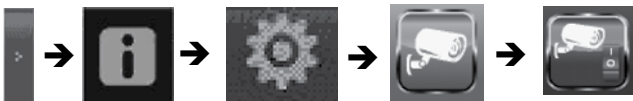

This screen should display:

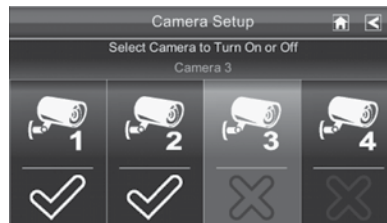

1. Tap the camera you want to turn on.
2. A check mark replaces the X under the camera.
3. To turn a camera off, tap the camera icon. An X replaces the checkmark and indicates the camera is turned off.

Although the camera is turned off, it is still powered. The monitor will not receive video signals from that camera.

BRIGHTNESS

From the pop-up menu, tap the following icons as they appear on the screens:

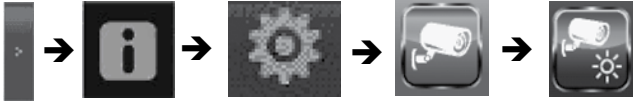

This screen should display:

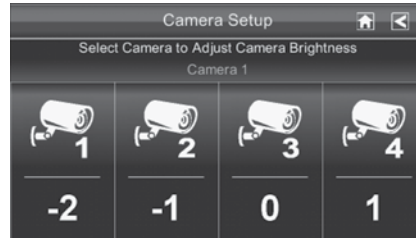

Tap the camera whose brightness level you want to change. The default brightness is 0, and the range is from -2 through 2.

RECORDER SETUP SCREEN

Use the *Recorder Setup* screen to select between *Motion Detection*, *Email Alert*, or *Schedule Record*.

MOTION DETECTION

From the pop-up menus, tap the following icons as they appear on the screens:

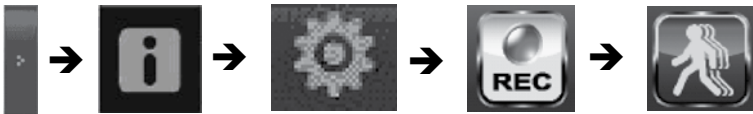

This screen should display:

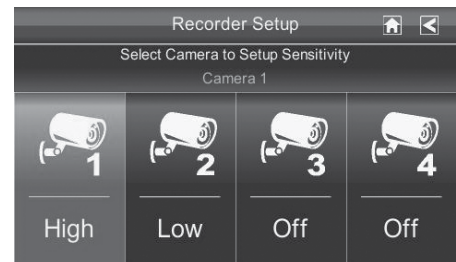
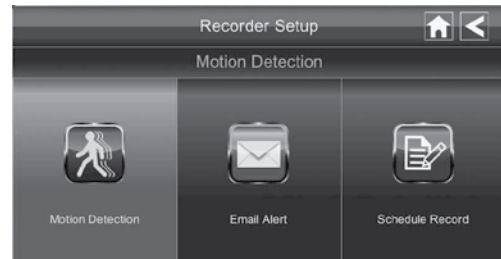

1. Each camera's motion detection sensitivity can be set independently. You can set the motion detection level to Off, Low, or High. Tap on the camera to cycle through these choices.

2. Tap  to return to the main *Motion Detection* screen.

The Motion Detection default setting is to Low. The system records for 2 minutes when motion is detected.

EMAIL ALERT

The Guardian Lullaboo firmware can notify you when cameras detect motion by sending you an e-mail alert. The e-mail alert contains information such as the time that motion was detected and by which camera. In order to enable this e-mail alert, you must enter both incoming and outgoing email addresses.

Uniden recommends you use Gmail to set up as the outgoing email server.

The outgoing email server (SMTP server) is responsible for sending out the email notification to tell users when motion is detected (Motion Detection must be activated).

The incoming mail server (Email To) receives the email notification sent from the SMTP server. The user must be able to receive email on a Windows PC or on mobile devices (such as an iPhone, iPad, or Android smartphone or tablet) to receive e-mail alerts from the system.

When you receive an email alert, you can view live video from your Windows PC, an iPhone, iPad, Android smartphone or Android tablet through apps. Free apps are available through the iTunes App store or the Android Market.

From the pop-up menus, tap the following icons as they appear on the screens:

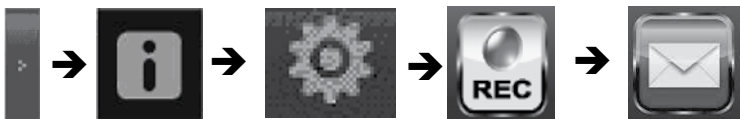

This screen should display:



1. Tap *Enable* to activate Email Alert or *Disable* to deactivate it.
2. Tap on the *SMTP Server* field. A keyboard screen displays.

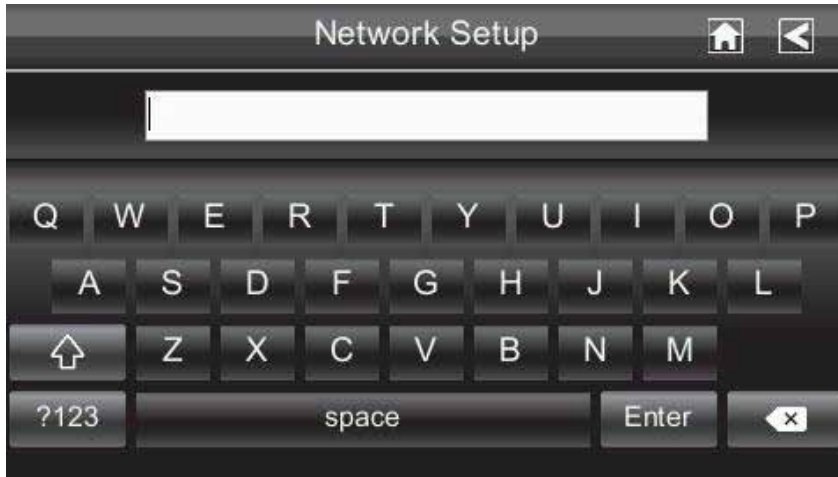

3. Enter your outgoing e-mail SMTP server (example: johndoe@gmail.com). You can switch the keyboard from alphabetical characters to numbers/symbols and back again by tapping the field to the left of the space bar. Tap Return. The *Email Alert* screen displays again.
4. Repeat the previous step for the *Password* field. Tap Return.

The password entered here must be the same password as the password for the outgoing email account.

5. Repeat Step 3 for the *Email To* field. Only one incoming email account will be accepted by the Guardian Lullaboo firmware. The incoming email account can be different from the outgoing email account.
6. Tap *OK* to save the settings, then tap < to return to the previous screen.

If you are using Gmail as the outgoing SMTP server, check SSL/TLS and use the data in the following table:

For Gmail

SMTP Server	Smtp.gmail.com	Enter this.
SMTP Port	465	Enter this.
Username	XXXX@gmail.com	Enter your gmail address in full, including @gmail.com.
Password	XXXXXXXXXX	Enter the password for this gmail account.
Email to	XXXX@gmail.com	Enter the email address where you want the alerts sent.

SCHEDULE RECORD

You can schedule up to 5 recording sessions. You are limited to the size of the SD card for how long a total recording time you have. These recording sessions must begin and end within a single 24-hour period. They cannot cross into the next day.

From the pop-up menus, tap the following icons as they appear on the screens:

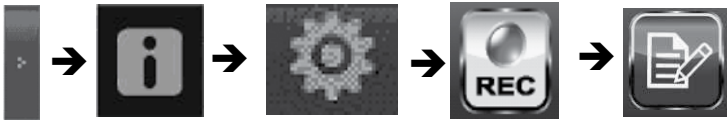

This screen should display:



1. Tap the camera number you want to record (1 - 4). You can select up to all 4 cameras to record.
2. Set the recording start time. Tap the hour and number boxes separately and use the **UP** and **DOWN** arrows to scroll through the times.
3. Tap the **AM/PM** block to toggle between them.

4. Tap on the blank Date box. The *Recorder Setup* calendar screen displays.
5. Tap on the date you want the recording. The previous screen displays.
6. Set up the recording and then tap **SAVE**. You can select another recording session to schedule, return the previous screen, or return to the *Live* screen.



Scheduled recordings are broken up into 15 minute file sizes. For example, if you record a 50 minute event, you will have three 15-minute recordings plus one 5-minute recording.

CLEAR A SCHEDULED RECORDING

1. Access the *Schedule Record* screen.
2. Tap recording you want to clear (1-5). The screen displays the settings for that schedule.
3. Tap **CLEAR**. The screen resets to the default values for that recording slot.

NETWORK SETUP SCREEN

The *Network Setup* screen allows you to select your internet connection type and security code. You can also display system default configuration.

From the pop-up menu, tap the following icons as they appear on the screens:

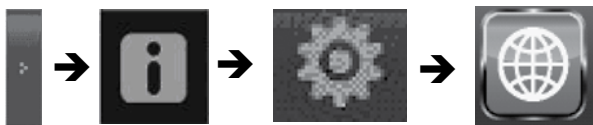

This screen should display:



INTERNET SETUP

1. Tap Internet Setup icon to display the *Internet Setup* screen.
2. Tap on your selection and fill in the fields requested. Tap **OK**.

Selection	Fields
Static IP	<ul style="list-style-type: none">• IP Address• Subnet Mask• Default Gateway• DNS Server
DHCP	None

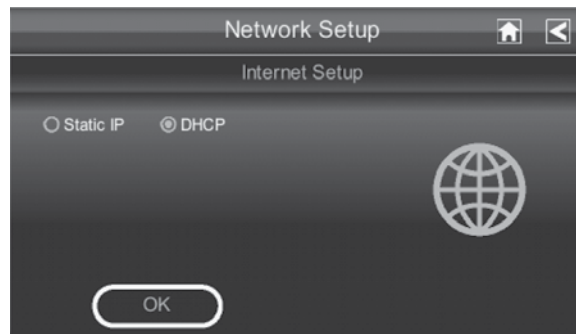

3. Tap **OK** at the system reboot prompt. The *Network Setup* screen displays.

DCHP is the most common connection. Your router will automatically assign an IP address to your Lullaboo system. Static IP is for those that have the ability to specify an IP address for the Lullaboo system.

SECURITY CODE

Set up your security code to limit who can have access to the system from a remote location.

1. Tap Security Code icon to display the *Security Code* screen.

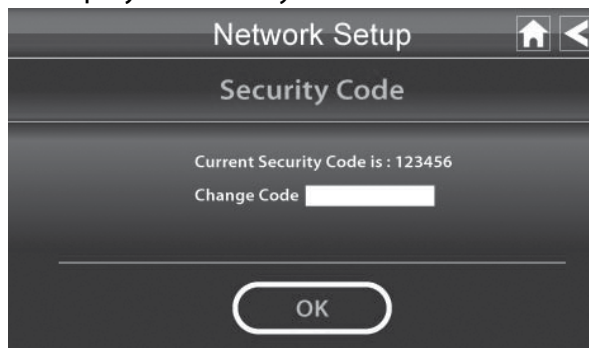

2. If you have not entered a security code, you can enter it here. If you have previously entered a security code, your current security code displays.

The default security code is set to 123456. We recommend that you change this code to something you will remember. You will need the code to access your video from a remote device such as a smart phone or PC.

3. Tap on the Change Code field. A keyboard screen displays.



4. Enter your security code. You can switch the keyboard from alphabetical characters to numbers/symbols and back by tapping the field to the left of the space bar. Tap Return. The *Security Code* screen displays again.

You must enter a security code to monitor your video from a PC or other device.

5. Tap **OK** on the system reboot prompt. The *Network Setup* screen displays.
6. Turn your Lullaboo monitor off then back on for the security code change to take effect.

NETWORK INFORMATION SCREEN

1. Tap the Network Information icon to display the *Network Information* screen.



2. Tap the  arrow to return to the previous screen.

The DID is a unique code specific to your monitor and is required (along with the security code) to gain remote access to your camera over the internet. The information in the DHCP setting is assigned to your monitor from your home router.

ALARM SETUP SCREEN

From the *Alarm Setup* screen, you can:

- Set the length of time the alarm sounds.
- Select a melody for the alarm.



PERIOD SCREEN

This selection allows you to select the length of time the alarm will sound for the alarm clock.

1. Tap Period. The *Change Siren Duration* screen displays.

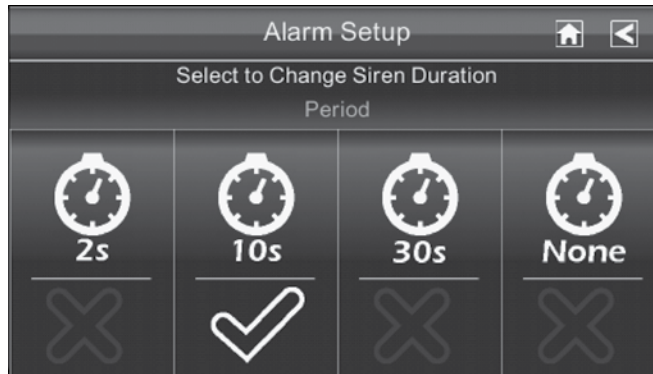

2. Tap the duration you want the siren to last (2, 10, or 30 seconds) or tap None to turn sirens off.
3. Tap  to return to the previous screen.

MELODY

This selection allows you to select a melody for the siren.

1. Tap Melody. The *Change Siren Melody* screen displays.

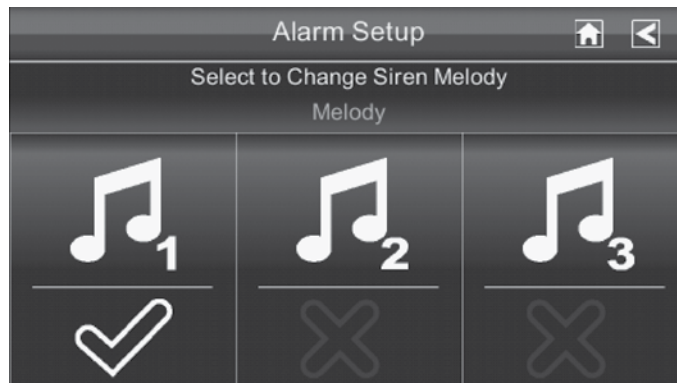

2. A check mark appears on the melody you tap and the monitor briefly plays a sample of the selected melody.
3. Tap the BACK arrow to return to the previous screen.

SYSTEM SETUP SCREEN

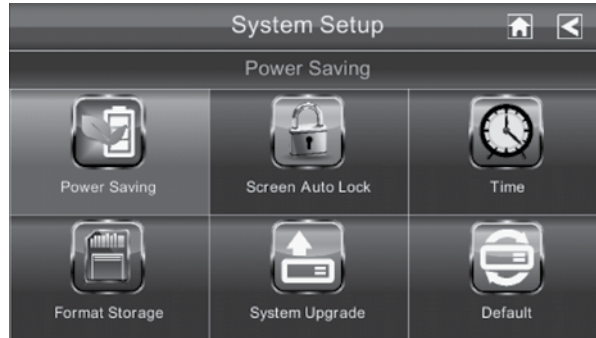



POWER SAVING

When you turn on Power Saving mode, the monitor goes into sleep mode (LCD turns off) after it is idle for 2 minutes. Press the **POWER** button once to reactivate the monitor. (Default = Disable).

If a motion detection event or scheduled recording begins, the LCD turns back on.

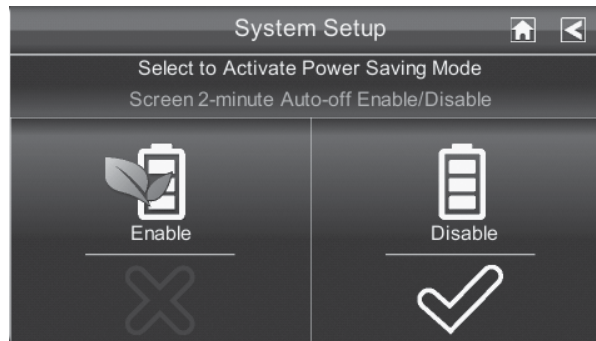
1. Tap Power Saving icon, then Enable to activate Power Saving mode (Default = Disable).



2. A check mark appears on your selection.
3. Tap  to return to the previous screen.

SCREEN AUTO LOCK

When you turn on Auto Lock mode, the monitor will automatically enter screen lock mode after it has been idle for 2 minutes. Auto Lock disables the touchscreen and removes the icons from the display.

When the auto-lock feature has been enabled and your Live screen is locked, just tap the **POWER** button once to unlock the screen and return to normal touch screen operation. At any time from the Live screen, you can manually lock the system by tapping the **POWER** button, whether or not the auto-lock feature has been enabled.

1. Tap Screen Auto Lock. The *Activate Touch Screen Operation Auto-lock* screen displays.

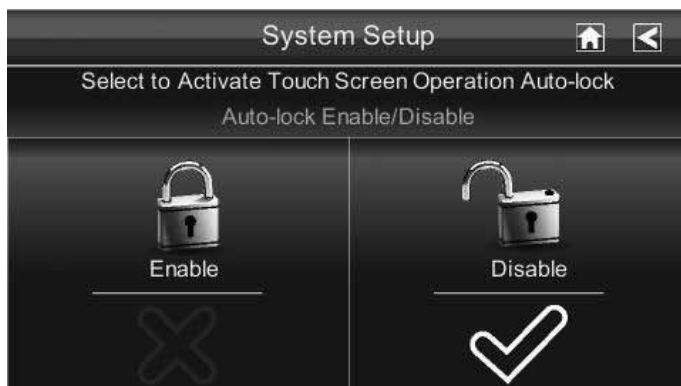

2. Tap your selection; a check mark displays.
3. Tap the **BACK** arrow to return to the previous screen.

TIME

The *Time* screen lets you set up clock alarms, set the system time, and set a timer.

From the pop-up menu, tap the following icons as they appear on the screens:

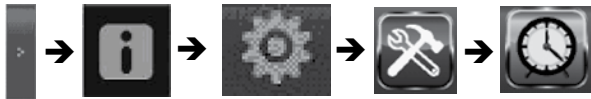

The following screen displays:



CLOCK ALARM

This feature operates as an independent alarm clock. It does not affect the operation of live video or recording video.

1. Tap  to display the *Clock Alarm* screen.

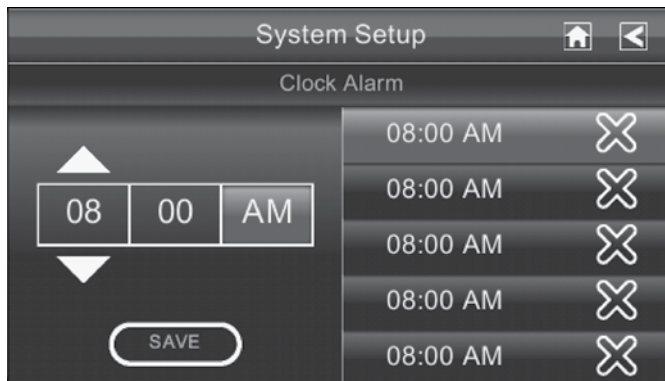

2. Tap on an alarm button (total of 5 to select from).
3. Tap on the hour block. The **UP/DOWN** arrows move to the hour block. Set the hour.

4. Tap on the minute block. The **UP/DOWN** arrows move to the minute block. Set the minute.
5. Tap on **AM/PM** to toggle between the two.
6. Tap **SAVE** when you are finished.

TIME SETTING

This screen contains fields to set the Month, Day, Year, Hour, Minute, and AM/PM.

1. Tap  to display the *Time Setting* screen.

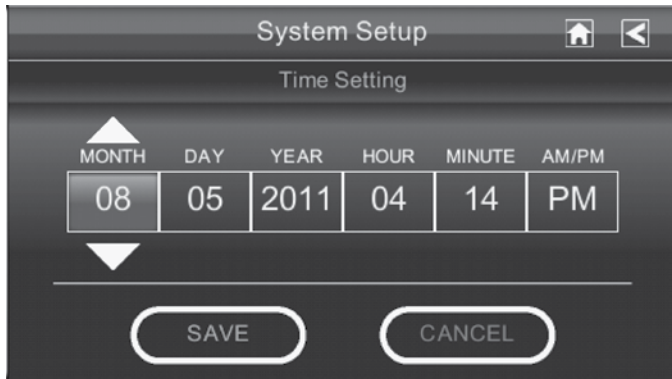

2. Tap on each field to set it. The **UP/DOWN** arrows shift to that field. Use **UP/DOWN** to set the field.
3. Tap on the AM/PM block to switch between the two.
4. Tap **SAVE** when you are finished.

It is important to set the correct time to ensure that the recorded video files and the scheduled record times are correct.

TIMER

This feature operates as an independent timer. It does not affect the operation of live video or recording video.

1. Tap  to display the *Timer* screen.

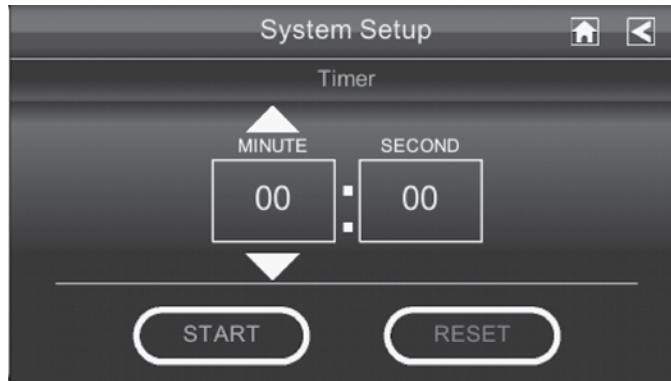

2. Tap on each field to set it. The **UP/DOWN** arrows shift to that field. Use **UP/DOWN** to set the field.
3. Tap **START** to begin the timer. When the timer reaches *00:00*, an alarm beeps until you tap **OK**.

FORMAT STORAGE

When using an SD card other than the one provided, it is highly recommended that you format the card using these procedures. Formatting any SD card deletes all files on that card.

From the pop-up menu, tap the following icons as they appear on the screens:



The Format Storage screen displays:

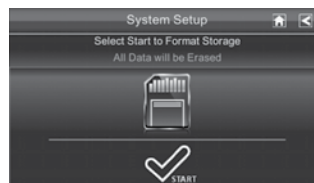

The Lullaboo system supports up to a 32 GB SD card.

1. Tap on **START**; a warning statement displays.
2. Tap **OK** to proceed to format storage or tap **CANCEL** to discontinue and return to the previous screen.
3. The system indicates success or failure.

SYSTEM UPGRADE

To upgrade the Uniden Guardian Lullaboo firmware, you will need to download the file from the Uniden website (www.uniden.com) to your computer. This file must then be transferred to the root directory of the SD card used in your Lullaboo baby monitor.

From the pop-up menu, tap the following icons as they appear on the screens:

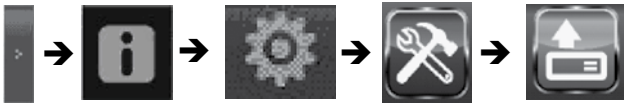

This screen should display:



LANGUAGE

CHANGING THE LANGUAGE

English is the default language. When you change languages, all system settings default to the original factory settings. You will have to reenter any specialized settings.

From the pop up menus, tap the following icons as they appear on the screens:

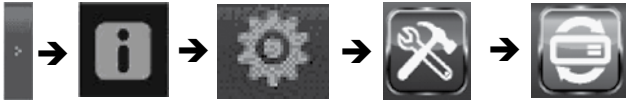

This screen should display:



1. Select a language to change to that language. The *Restore Default Settings* screen displays.
 2. Tap **OK** to continue with the language reset. The system will reboot in about 5 seconds. If you do not want to reset the language, tap **CANCEL** and return to the previous screen.
- Changing the language will reboot the system and ask you to recalibrate the touch screen. Follow the instructions on the screen.

QUICK TIPS

The *Quick Tips* screen provides more detail into 10 common areas. Tap on a subject to display the information.

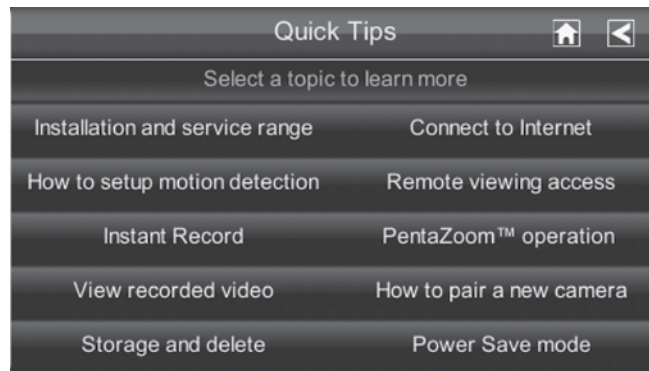

REMOTE ACCESS

OVERVIEW

Uniden's Lullaboo baby monitor lets you view live video from your Windows® PC, an iPhone®, iPad®, or Android™ smartphone or tablet. Free apps are available through the iTunes® App Store or the Android Market.

This system uses P2P remote access technology and does not require configuring your router, port forwarding or a remote DDNS service.

The number of remote viewers is determined by the amount of "available upload bandwidth" on your home network. Each remote viewer requires ~350kbps of bandwidth on the network.

SYSTEM REQUIREMENTS

- Microsoft® Windows XP, Vista, or Windows 7
- Internet Explorer® 8 or greater.
- iPhone® or
- iPad® or
- Android™ smartphone or tablet

CONNECTING TO THE INTERNET

The cradle charges your monitor as well as provides an internet connection. When you are connected to the internet, live video will not display on the monitor.

For this procedure, the AC adapter must be connected to the cradle and not to the monitor. Reconnect the AC adapter if necessary.

1. Connect one end of the Ethernet cable into the back of the cradle ("Getting to Know the Monitor and Camera" on page 6).

2. Connect the other end into your primary router (typically, the router from your service provider).
3. Place cradle maximum distance away from your router.
4. Insert the monitor into the cradle. A screen asks if you want to connect to the internet or to only charge the monitor.
5. Tap *Connect*. The Internet Connection Status Indicator appears on the upper left of the LIVE screen indicating that the system is connected to the internet.
While the system is connected to the internet:
 - ▶ The LIVE screen display rate may reduce to 2 - 3 frames per second.
 - ▶ The touch screen's control operation will be limited. To return to full control of the touch screen, disconnect from the internet. Tap on the Pop Up menu and then select *Charge Only*.
6. When you connect remotely to the monitor, the Internet Connection Status Indicator shows that remote view is in progress.

CONNECTING TO THE INTRANET (HOME NETWORK)

When the monitor is placed in the cradle and "charge only" is selected, you can still access your live video from a PC or smart phone as long as those devices are also connected to the same network as the monitor. For example your smart phone is connected to your home network via WiFi. In this case, live video will still be displayed on the monitor as well as on the smart phone.

DOWNLOADING AND USING THE APPS

ANDROID™

DOWNLOAD

You can use a Google® Android™ smart phone or tablet with your system to remotely connect to and view live camera video. Follow these steps to download, add, and use the app.

1. From your Android™ smart phone or tablet device, search the Android Market for *Uniden Guardian*.
2. Download and install this app to your device.
3. Launch the app; select *Add* to add your system information to the app.
4. Enter a name for your system in the *System Name* field.
5. Enter the same DID code from the back of your Lullaboo monitor in the *DID* field.
6. Enter the same security code that you set on your Lullaboo monitor in the *Security Code* field.
7. Select *Save*.
8. Select the system you wish to view.

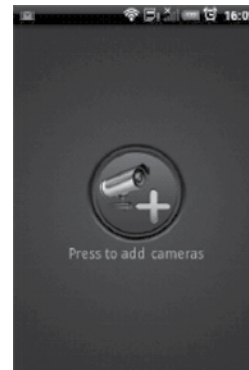

APP OPERATION

When you open the APP on your Android phone, the image displayed on the main screen is the last camera image, captured automatically, from your previously established session.

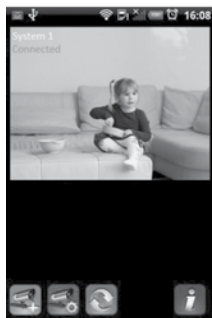

Main screen



Tap to add an additional Guardian system.



Tap to enter *System Setup* page.



Tap to refresh the system.



Tap to enter the APP *Information* page. The screen displays the APP version number and the API version number. Tap *OK* to exit.

If you have multiple systems, scroll down and tap on the system image you want to view.

To View Video:

1. Select a system.
2. Select a camera from the drop-down menu.
3. View video.



You can turn your device sideways and go to a horizontal view.

4. Tap *Return* to stop the video and enter the system page.

To Take Snapshots from Video:

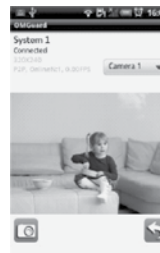
Two icons display on the screen - Snapshot and Return.



	Snapshot icon. Tap to take a picture.
	Return icon. Tap to return to the Main screen

IPHONE®

In a similar fashion to the Android smart phone, you can use the Apple® iPhone® smart phone or iPad® tablet with your Lullaboo system to remotely connect to and view camera videos. Follow these steps to download the Uniden Guardian iPhone® App and set it up to work with your Lullaboo.

DOWNLOAD

1. From your iPhone® or iPad®, go to the iTunes® App Store and search for *Uniden Guardian*.
2. Download and install this App to your device.
3. Launch the app; select *Settings* then **ADD** to add your system information to the App.
4. Enter a name for your system in the *System Name* field.
5. Enter the same DID code from your Lullaboo monitor in the *DID* field.
6. Enter the same security code that you set on your Lullaboo monitor in the *Security Code* field.
7. Tap *Save*.

When you tap Save, the video streams automatically with Camera 1 selected by default.

APP OPERATION

When you open the APP on your iPhone or iPad, several icons display on the bottom task bar.

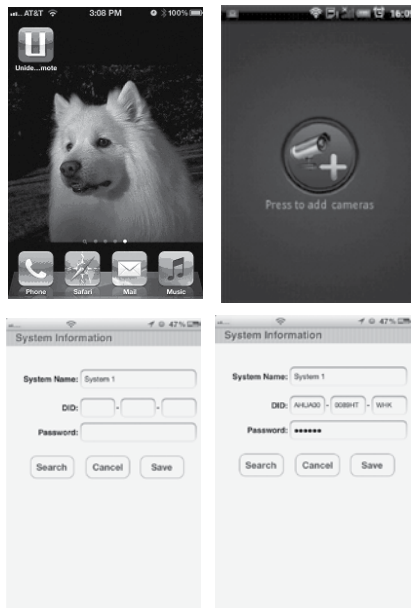



Main screen



Tap to add an additional Guardian system.



Tap to enter *System Setup* page.



Tap to refresh the system.



Tap to enter the *APP Information* page. The screen displays the APP version number and the API version number. Tap *OK* to exit.

If you have multiple systems, scroll down and tap on the system image you want to view.

TO VIEW VIDEO:

1. Select a system.
2. Select a camera from the drop-down menu.
3. View video.

You can turn your device sideways and go to a horizontal view.

4. Tap *Return* to stop the video and enter the system page.

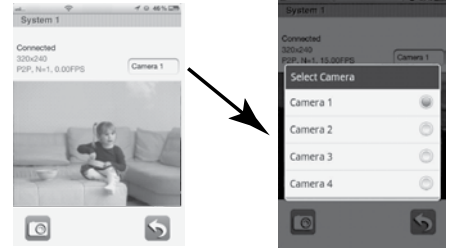

TO TAKE SNAPSHOTS FROM VIDEO:

Two icons display on the screen - Snapshot and Return.

	<p>Snapshot icon. Tap to take a picture.</p>
	<p>Return icon. Tap to return to the Main screen.</p>

SOLVING PROBLEMS

If you have any trouble with your system, try these simple steps. If you are still having a problem with your camera, check the manual that came with your camera. If you still have a question, call our Customer Care Line; see “Customer Care” on page 2.

If...	Try..
The motion sensor won't respond to movement.	<ul style="list-style-type: none"> • Increasing the sensitivity of the motion sensor (see page 20). • Checking the settings on the <i>Record</i> screen (see page 18).
The motion sensor goes off when there's nothing there.	<ul style="list-style-type: none"> • Decreasing the sensitivity of the motion sensor (see page 20). • Refer to “Placement Considerations” on page 8.
I can't play my video clips in another program	<ul style="list-style-type: none"> • The video files play with a Quicktime® player. Download this free player from www.apple.com. • Video will play in players such as Windows Media® Player if an H.264 CODEC plug-in is installed.
I schedule a recording, save the schedule, and the recording does not happen at the scheduled time.	<ul style="list-style-type: none"> • Ensure that the system time is set to the current time. • Make sure that the SD card is inserted into the monitor and there is still memory available on that card.
The camera's signal status icon shows no bars	<ul style="list-style-type: none"> • Making sure the camera is plugged in and the blue LED is on. • Making sure the camera is paired to the correct channel. • Re-pairing the camera and monitor. • Moving the camera closer to the monitor; it might be out of range. • Make sure the camera setting is turned on in Camera Setup (see “Camera On” on page 21).
The camera's signal status icon shows one or two bars or the video quality is poor	See “General Guidelines” on page 8 for tips on improving video quality.

If...	Try..
The camera won't pair with the monitor	<ul style="list-style-type: none"> • Making sure the camera is plugged in and the blue (Power) LED is on and the yellow (Pairing) LED is flashing. • Pressing and releasing the pairing button quickly. Do not press and hold the pairing button.
When I power up my monitor and camera for the first time, it seems to be on but there is no picture on the screen	<ul style="list-style-type: none"> • If the Power Saving feature has been turned on, the monitor's LCD screen will power off. Tap POWER to turn the LCD back on.
I have my regular <i>Live</i> screen but there are no icons.	<ul style="list-style-type: none"> • tapping POWER on top of the monitor. Screen lock may be on and tapping POWER will unlock the screen.

ADDITIONAL INFORMATION

PRODUCT SPECIFICATIONS

Radio Frequency Transceiver	
RF Frequency	2.4 GHz
Modulation	GFSK
Spread spectrum	Frequency Hopping
Anti Interference	Clean Channel Dynamic Select
Selectable camera channel	4
Data rate	2 Mbps
Transmitting range	500 feet (152 meters) in an open area (line of sight)

Image Specification	
Output Image resolution	480 X 272, 320 x 240 (QVGA)
Image processing	H.264
Exposure	Auto
White balance	Auto

System Specifications	Camera	Monitor
Weight	4.1 oz (118 g)	G403: 7 oz (198 g)
Dimension	3.2 x 2.9 x 0.8" (90 x 49 x 20 mm)	5 x 3 x 0.9" (132 x 79 x 24 mm)
Operating temperature	+14° F (-10° C) to 122° F (+50° C)	
Battery charging temp.	0° C (32° F) to +45° C (113° F)	
Input voltage	100-240 V AC @ 60 or 50 Hz	

System Specifications	Camera	Monitor
Operating voltage	5 V DC @ 1 Amp	
Power consumption	650 mA max	
Low light solution	12 IR LEDs, 1 Low light sensor	
Low light sensitivity	1-8 lux	
Picture sensor	OV7725 1/4' Color CMOS	
Lens	F3.6mm H:53 V:40	

Lithium-Polymer Battery Warning

- This equipment contains a rechargeable lithium-polymer battery.
- Do not charge the battery in temperatures below 32° F (0° C) or higher than 113° F (45° C).
- Do not open or mutilate the battery.
- The rechargeable batteries contained in this equipment may explode if disposed of in a fire.
- Do not short-circuit the battery.
- Do not charge the rechargeable battery pack used in this equipment with any charger other than the one designed to charge this battery pack as specified in the owner's manual. Using another charger may damage the battery pack or cause the battery pack to explode.

CAUTION! Rechargeable Batteries Must Be Recycled or Disposed of Properly.

Recycling and Disposal Information

- Do not dispose of electronic devices or any of their components (especially batteries and LCD displays) in your municipal trash collection.
- Consult your local waste management authority or a recycling organization like Earth911.com to find an electronics recycling facility in your area.

- If you are unable to locate proper recycling facilities in your area, please return this product to Uniden for recycling.

FCC Compliance Information

Part 15 Compliance Statement

This device complies with Part 15 of the FCC Rules. Operation is subjected to the following two conditions: (1) this device may not cause harmful interference, and (2) this device must accept any interference received, including interference that may cause undesired operation.

This equipment has been tested and found to comply with limits for a Class B digital device, pursuant to Part 15 of the FCC rules and ETSI (EN) 300328. These limits are designed to provide reasonable protection against harmful interference in residential installations. This equipment generates, uses, and can radiate radio frequency energy, and if not installed and used in accordance with the instructions, may cause harmful interference to radio communications.

However, there is no guarantee that interference will not occur in a particular installation. If this equipment does cause interference to radio or television equipment reception, which can be determined by turning the equipment off and on, the user is encouraged to try to correct the interference by one or more of the following measures:

- Reorient or relocate the receiving antenna.
- Move the equipment away from the monitor.
- Plug the equipment into an outlet on a circuit different from that to which the monitor is connected.
- Consult the dealer or an experienced radio/television technician for additional suggestions.

CAUTION! Any changes or modifications to this equipment not expressly approved by the party responsible for compliance could void your authority to operate the equipment.

RF Exposure Information

The antenna used for this transmitter must be installed to provide a separation distance of at least 20 cm (7.9") from all persons and must not be collocated or operating in conjunction with any other antenna or transmitter.

IC Compliance Information

Radio Equipment Notice

The term “IC:” before the radio certification number only signifies that Industry Canada technical specifications were met. Operation is subject to the following two conditions: (1) this device may not cause interference, and (2) this device must accept any interference, including interference that may cause undesired operation of the device. “Privacy of communications may not be ensured when using this device”.

CE Compliance Information

Products with CE Marking comply with EMC Directive (2004/108/EC); Low Voltage Directive (73/23/EEC); R&TTE(1999/5/EC) issued by the Commission of the European Community. Compliance with these directives implies conformity to the following European Norms:

- EMC: EN 301 489
- LVD: EN 60950
- Radio: EN 300 328

Three-Year Limited Warranty

Important: Evidence of original purchase is required for warranty service.

WARRANTOR: Uniden America Corporation (“Uniden”) ELEMENTS OF WARRANTY: Uniden warrants, for three years, to the original retail owner, this Uniden Product to be free from defects in materials & craftsmanship with only the limitations or exclusions set out below.

WARRANTY DURATION: This warranty to the original user shall terminate & be of no further effect 36 months after the date of original retail sale. The warranty is invalid if the Product is (A) damaged or not maintained as reasonable or necessary, (B) modified, altered, or used as part of any conversion kits, subassemblies, or any configurations not sold by Uniden, (C) improperly installed, (D) serviced or repaired by someone other than an authorized Uniden service center for a defect or malfunction covered by this warranty, (E) used in any conjunction with equipment or parts or as part of any system not manufactured by Uniden, or (F) installed or programmed by anyone other than as detailed by the owner’s manual for this product.

STATEMENT OF REMEDY: In the event that the product does not conform to this warranty at any time while this warranty is in effect, warrantor will either, at its option, repair or replace the defective unit & return it to you without charge for parts, service, or any other cost (except shipping & handling) incurred by warrantor

or its representatives in connection with the performance of this warranty. Warrantor, at its option, may replace the unit with a new or refurbished unit.

THE LIMITED WARRANTY SET FORTH ABOVE IS THE SOLE & ENTIRE WARRANTY PERTAINING TO THE PRODUCT & IS IN LIEU OF & EXCLUDES ALL OTHER WARRANTIES OF ANY NATURE WHATSOEVER, WHETHER EXPRESS, IMPLIED OR ARISING BY OPERATION OF LAW, INCLUDING, BUT NOT LIMITED TO ANY IMPLIED WARRANTIES OF MERCHANTABILITY OR FITNESS FOR A PARTICULAR PURPOSE. THIS WARRANTY DOES NOT COVER OR PROVIDE FOR THE REIMBURSEMENT OR PAYMENT OF INCIDENTAL OR CONSEQUENTIAL DAMAGES. Some states do not allow this exclusion or limitation of incidental or consequential damages so the above limitation or exclusion may not apply to you.

LEGAL REMEDIES: This warranty gives you specific legal rights, & you may also have other rights which vary from state to state. This warranty is void outside the United States of America & Canada.

PROCEDURE FOR OBTAINING PERFORMANCE OF WARRANTY: If, after following the instructions in the owner's manual you are certain that the Product is defective, pack the Product carefully (preferably in its original packaging). Disconnect the battery from the Product & separately secure the battery in its own separate packaging within the shipping carton. The Product should include all parts & accessories originally packaged with the Product. Include evidence of original purchase & a note describing the defect that has caused you to return it. The Product should be shipped freight prepaid, by traceable means, to warrantor at:

Uniden America Service

4700 Amon Carter Blvd. Fort Worth, TX 76155

Uniden®

© 2013 Uniden
America Corporation

All rights reserved
Printed in China