



Pepwave MAX User Manual

Pepwave Products:

MAX 700/HD2/HD2 IP67/HD2 mini/HD4/Transit/BR1/BR1 Mini/BR1 Slim/BR1 ENT/BR1 Pro
LTE/BR1 IP55/BR2 IP55/On-The-Go/MAX HD2/HD4 with MediaFast

Pepwave Firmware 7
January 2017

Copyright & Trademarks

Specifications are subject to change without notice. Copyright © 2017 Pepwave Ltd. All Rights Reserved. Pepwave and the Pepwave logo are trademarks of Pepwave Ltd. Other brands or products mentioned may be trademarks or registered trademarks of their respective owners.

Table of Contents

Introduction and Scope	8
Glossary	9
Product Features	10
Supported Network Features	10
WAN	10
LAN	11
VPN	11
Firewall	12
Captive Portal	12
Outbound Policy	12
AP Controller	12
QoS	12
Other Supported Features	13
Pepwave MAX Mobile Router Overview	14
MAX 700	14
MAX HD2	16
MAX HD2 IP67	18
MAX HD2 mini	19
MAX Transit	20
MAX HD4	22
MAX BR1	23
MAX BR1 Slim	25
MAX BR1 Pro LTE	27
MAX Hotspot	29
BR1 Mini	30
MAX BR1/2 IP55	31
MAX On-The-Go	32

Advanced Feature Summary	34
Drop-in Mode and LAN Bypass: Transparent Deployment	34
QoS: Clearer VoIP	35
Per-User Bandwidth Control	35
High Availability via VRRP	36
USB Modem and Android Tethering	36
Built-In Remote User VPN Support	37
SIM-card USSD support	38
Installation	38
Preparation	38
Constructing the Network	39
Configuring the Network Environment	39
Mounting the Unit	40
Wall Mount	40
Car Mount	40
IP67 Installation Guide	40
Connecting to the Web Admin Interface	41
Configuring the LAN Interface(s)	42
Basic Settings	42
Port Settings	53
Captive Portal	53
Configuring the WAN Interface(s)	56
Ethernet WAN	57
DHCP Connection	59
Static IP Connection	60
PPPoE Connection	61
L2TP Connection	63
Cellular WAN	64
Wi-Fi WAN	70
Creating Wi-Fi Connection Profiles	77

WAN Health Check	78
Dynamic DNS Settings	81
Advanced Wi-Fi Settings	82
MediaFast Configuration	87
Setting Up MediaFast Content Caching	87
Scheduling Content Prefetching	88
Viewing MediaFast Statistics	89
Bandwidth Bonding SpeedFusion™ / PepVPN	91
PepVPN	91
The Pepwave Router Behind a NAT Router	98
SpeedFusion™ Status	99
IPsec VPN	99
IPsec VPN Settings	99
Outbound Policy Management	104
Outbound Policy	104
Custom Rules for Outbound Policy	106
Algorithm: Weighted Balance	106
Algorithm: Persistence	108
Algorithm: Enforced	109
Algorithm: Priority	109
Algorithm: Overflow	110
Algorithm: Least Used	110
Algorithm: Lowest Latency	111
Expert Mode	111
Inbound Access	112
Port Forwarding Service	112
UPnP / NAT-PMP Settings	114
NAT Mappings	115
QoS	116

User Groups	116
Bandwidth Control	117
Application	118
Application Prioritization	118
Prioritization for Custom Applications	118
DSL/Cable Optimization	119
Firewall	119
Outbound and Inbound Firewall Rules	120
Access Rules	120
Apply Firewall Rules to PepVpn Traffic	123
Intrusion Detection and DoS Prevention	124
Content Blocking	125
Application Blocking	126
Web Blocking	126
Customized Domains	126
Exempted User Groups	126
Exempted Subnets	126
URL Logging	127
OSPF & RIPv2	127
Remote User Access	129
Miscellaneous Settings	131
High Availability	131
PPTP Server	135
Certificate Manager	137
Service Forwarding	137
SMTP Forwarding	138
Web Proxy Forwarding	139
DNS Forwarding	139
Custom Service Forwarding	139
Service Passthrough	140

GPS Forwarding	141
AP Controller	142
Wireless SSID	142
Settings	147
AP Controller Status	153
Info	153
Access Point (Usage)	154
Wireless SSID	157
Wireless Client	158
Nearby Device	159
Event Log	160
Toolbox	161
System Settings	162
Admin Security	162
Firmware	166
Time	167
Schedule	167
Email Notification	169
Event Log	171
SNMP	172
InControl	175
Configuration	175
Feature Add-ons	177
Reboot	177
Tools	177
Ping	177
Traceroute Test	178
PepVPN Test	179
Wake-on-LAN	180
CLI (Command Line Interface Support)	180

Status	182
Device	182
GPS Data	183
Active Sessions	183
Client List	185
WINS Client	186
UPnP / NAT-PMP	186
SpeedFusion Status	187
Event Log	191
Bandwidth Status	192
Real-Time	193
Hourly	193
Daily	194
Monthly	195
Appendix B: Declaration	199

1 Introduction and Scope

Pepwave routers provide link aggregation and load balancing across multiple WAN connections, allowing a combination of technologies like 3G HSDPA, EVDO, 4G LTE, Wi-Fi, external WiMAX dongle, and satellite to be utilized to connect to the Internet.

The MAX wireless SD-WAN router series has a wide range of products suitable for many different deployments and markets. Entry level SD-WAN models such as the MAX BR1 are suitable for SMEs or branch offices. High-capacity SD-WAN routers such as the MAX HD2 are suitable for larger organizations and head offices.

This manual covers setting up Pepwave routers and provides an introduction to their features and usage.

Tips

Want to know more about Pepwave routers? Visit our YouTube Channel for a video introduction!

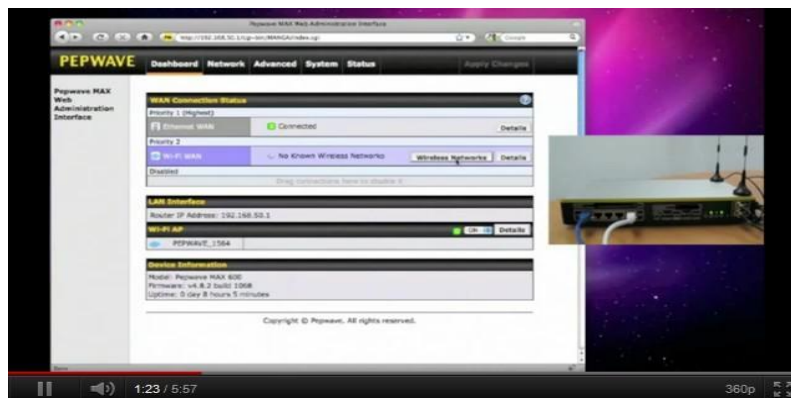

<http://youtu.be/UckVQThLKO4>

2 Glossary

The following terms, acronyms, and abbreviations are frequently used in this manual:

Term	Definition
3G	3rd generation standards for wireless communications (e.g., HSDPA)
4G	4th generation standards for wireless communications (e.g., LTE)
DHCP	Dynamic Host Configuration Protocol
DNS	Domain Name System
EVDO	Evolution-Data Optimized
FQDN	Fully Qualified Domain Name
HSDPA	High-Speed Downlink Packet Access
HTTP	Hyper-Text Transfer Protocol
ICMP	Internet Control Message Protocol
IP	Internet Protocol
LAN	Local Area Network
MAC Address	Media Access Control Address
MTU	Maximum Transmission Unit
MSS	Maximum Segment Size
NAT	Network Address Translation
PPPoE	Point to Point Protocol over Ethernet

QoS	Quality of Service
SNMP	Simple Network Management Protocol
TCP	Transmission Control Protocol
UDP	User Datagram Protocol
VPN	Virtual Private Network
VRRP	Virtual Router Redundancy Protocol
WAN	Wide Area Network
WINS	Windows Internet Name Service
WLAN	Wireless Local Area Network

3 Product Features

Pepwave routers enable all LAN users to share broadband Internet connections, and they provide advanced features to enhance Internet access. Our Max BR wireless routers support multiple SIM cards. They can be configured to switch from using one SIM card to another SIM card according to different criteria, including wireless network reliability and data usage.

Our MAX HD series wireless routers are embedded with multiple 4G LTE modems, and allow simultaneous wireless Internet connections through multiple wireless networks. The wireless Internet connections can be bonded together using our SpeedFusion technology. This allows better reliability, larger bandwidth, and increased wireless coverage are comparing to use only one 4G LTE modem.

Below is a list of supported features on Pepwave routers. Features vary by model. For more information, please see peplink.com/products.

3.1 Supported Network Features

3.1.1 WAN

- Ethernet WAN connection in full/half duplex
- Static IP support for PPPoE

- Built-in cellular modems
- USB mobile connection(s)
- Wi-Fi WAN connection
- Network address translation (NAT)/port address translation (PAT)
- Inbound and outbound NAT mapping
- IPsec NAT-T and PPTP packet passthrough
- MAC address clone and passthrough
- Customizable MTU and MSS values
- WAN connection health check
- Dynamic DNS (supported service providers: changeip.com, dyndns.org, no-ip.org, tzo.com and DNS-O-Matic)
- Ping, DNS lookup, and HTTP-based health check

3.1.2 LAN

- Wi-Fi AP
- Ethernet LAN ports
- DHCP server on LAN
- Extended DHCP option support
- Static routing rules
- VLAN on LAN support

3.1.3 VPN

- PepVPN with SpeedFusion™
- PepVPN performance analyzer
- X.509 certificate support
- VPN load balancing and failover among selected WAN connections
- Bandwidth bonding and failover among selected WAN connections
- IPsec VPN for network-to-network connections (works with Cisco and Juniper only)
- Ability to route Internet traffic to a remote VPN peer
- Optional pre-shared key setting
- SpeedFusion™ throughput, ping, and traceroute tests

- PPTP server
- PPTP and IPsec passthrough

3.1.4 Firewall

- Outbound (LAN to WAN) firewall rules
- Inbound (WAN to LAN) firewall rules per WAN connection
- Intrusion detection and prevention
- Specification of NAT mappings
- Outbound firewall rules can be defined by destination domain name

3.1.5 Captive Portal

- Splash screen of open networks, login page for secure networks
- Customizable built-in captive portal
- Supports linking to outside page for captive portal

3.1.6 Outbound Policy

- Link load distribution per TCP/UDP service
- Persistent routing for specified source and/or destination IP addresses per TCP/UDP service
- Traffic prioritization and DSL optimization
- Prioritize and route traffic to VPN tunnels with Priority and Enforced algorithms

3.1.7 AP Controller

- Configure and manage Pepwave AP devices
- Review the status of connected APs

3.1.8 QoS

- Quality of service for different applications and custom protocols
- User group classification for different service levels
- Bandwidth usage control and monitoring on group- and user-level

- Application prioritization for custom protocols and DSL/cable optimization

3.2 Other Supported Features

- User-friendly web-based administration interface
- HTTP and HTTPS support for web admin interface
- Configurable web administration port and administrator password
- Firmware upgrades, configuration backups, ping, and traceroute via web admin interface
- Remote web-based configuration (via WAN and LAN interfaces)
- Time server synchronization
- SNMP
- Email notification
- Read-only user for web admin
- Shared IP drop-in mode
- Authentication and accounting by RADIUS server for web admin
- Built-in WINS servers*
- Syslog
- SIP passthrough
- PPTP packet passthrough
- Event log
- Active sessions
- Client list
- WINS client list *
- UPnP / NAT-PMP
- Real-time, hourly, daily, and monthly bandwidth usage reports and charts
- IPv6 support
- Support USB tethering on Android 2.2+ phones

* Not supported on MAX Surf-On-The-Go, and BR1 variants

4 Pepwave MAX Mobile Router Overview

4.1 MAX 700

4.1.1 Panel Appearance

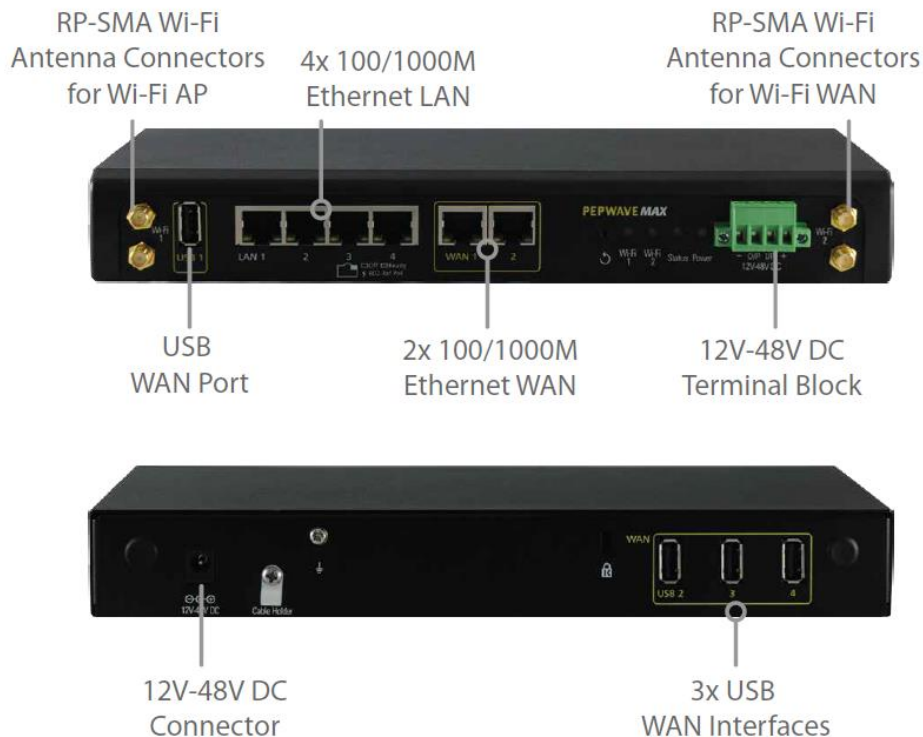

4.1.2 LED Indicators

The statuses indicated by the front panel LEDs are as follows:

Status Indicators		
Status	OFF	System initializing
	Red	Booting up or busy
	Blinking red	Boot up error
	Green	Ready

Wi-Fi AP and Wi-Fi WAN Indicators		
Wi-Fi WAN	OFF	Disconnected
	Blinking slowly	Connecting to network
	Blinking	Connected to network with traffic
	ON	Connected to network without traffic
Wi-Fi AP	OFF	Disabled
	Blinking slowly	Enabled but no client connected
	Blinking	Connected to network with traffic
	ON	Client(s) connected to wireless network

LAN and Ethernet WAN Ports		
Green LED	ON	10 / 100/ 1000 Mbps
	Blinking	Data is transferring
Orange LED	OFF	No data is being transferred or port is not connected
Port Type	Auto MDI/MDI-X ports	

4.2 MAX HD2

4.2.1 Panel Appearance

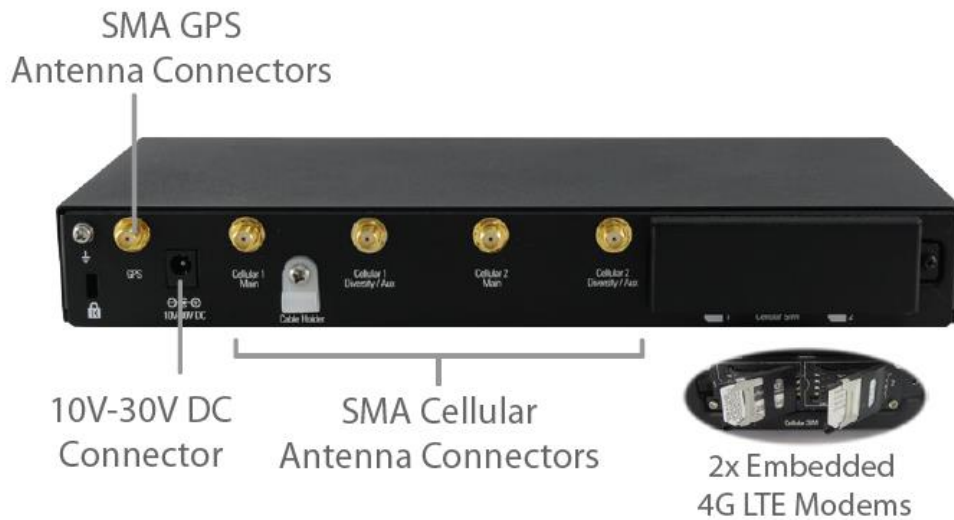
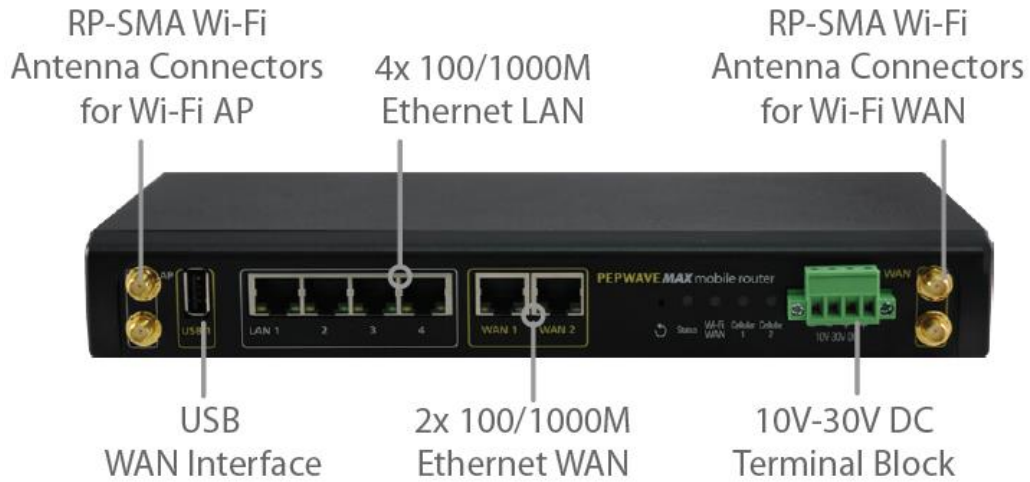

4.2.2 LED Indicators

The statuses indicated by the front panel LEDs are as follows:

Status Indicators		
Status	OFF	System initializing
	Red	Booting up or busy
	Blinking red	Boot up error
	Green	Ready

Wi-Fi AP and Wi-Fi WAN Indicators		
Wi-Fi WAN / Cellular 1 / Cellular 2	OFF	Disabled Intermittent
	Blinking slowly	Connecting to wireless network(s)
	Blinking	Connected to wireless network(s) with traffic
	ON	Connected to wireless network(s) without traffic

LAN and Ethernet WAN Ports		
Green LED	ON	10 / 100 / 1000 Mbps
	Blinking	Data is transferring
Orange LED	OFF	No data is being transferred or port is not connected
	Port Type	Auto MDI/MDI-X ports

4.3 MAX HD2 IP67

4.3.1 Panel Appearance



The statuses indicated by the front panel LEDs are as follows:

Status Indicators		
Status	OFF	System initializing
	Red	Booting up or busy
	Blinking red	Boot up error
	Green	Ready

4.4 MAX HD2 mini

4.4.1 Panel Appearance

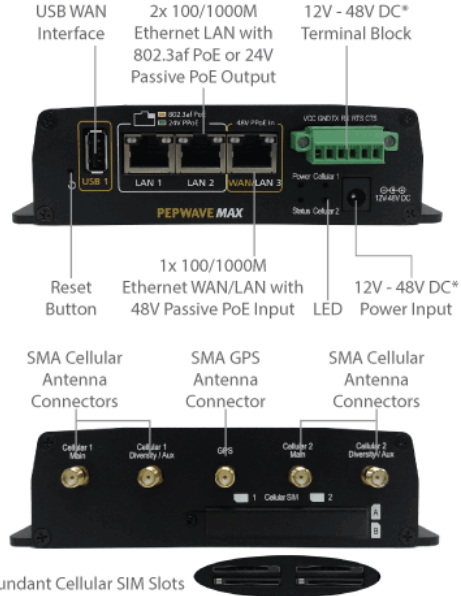
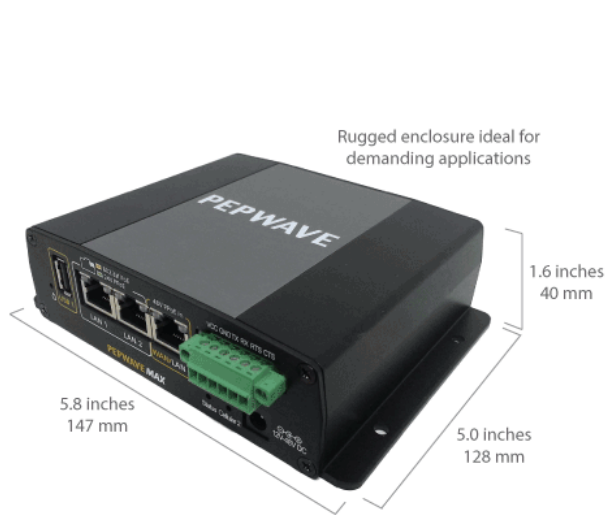

*With 48V DC power, all 3 Ethernet ports can act as 802.3af PoE or 24V Passive PoE outputs

4.4.2 LED Indicators

The statuses indicated by the front panel LEDs are as follows:

Status Indicators		
Status	OFF	System initializing
	Red	Booting up or busy
	Blinking red	Boot up error
	Green	Ready

Cellular WAN Indicators		
Cellular 1 / Cellular 2	OFF	Disabled intermittent
	Blinking slowly	Connecting to wireless network(s)
	Blinking	Connected to wireless network(s) with traffic

	ON	Connected to wireless network(s) without traffic
--	----	--

LAN and Ethernet WAN Ports		
Green LED	ON	10 / 100 / 1000 Mbps
	Blinking	Data is transferring
Orange LED	OFF	No data is being transferred or port is not connected
Port Type	Auto MDI/MDI-X ports	

4.5 MAX Transit

4.5.1 Panel Appearance

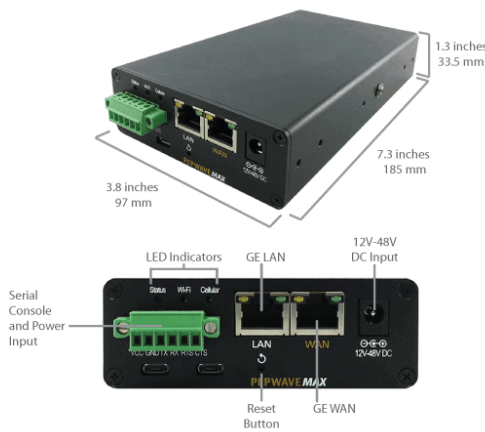

MAX-TST

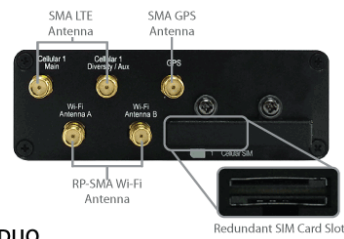

MAX-TST-DUO

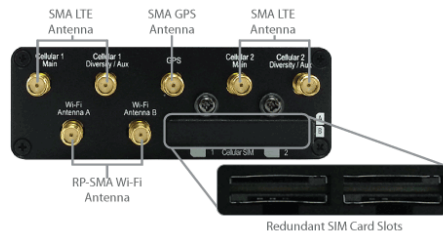

4.5.2 LED Indicators

The statuses indicated by the front panel LEDs are as follows:

Status Indicators		
Status	OFF	System initializing
	Red	Booting up or busy
	Blinking red	Boot up error
	Green	Ready

Cellular WAN Indicators		
	OFF	Disabled intermittent
Cellular 1 / Cellular 2*	Blinking slowly	Connecting to wireless network(s)
	Blinking	Connected to wireless network(s) with traffic
	ON	Connected to wireless network(s) without traffic

* For MAX-TST_DUO

LAN and Ethernet WAN Ports		
Green LED	ON	10 / 100 / 1000 Mbps
	Blinking	Data is transferring
Orange LED	OFF	No data is being transferred or port is not connected
Port Type	Auto MDI/MDI-X ports	

4.6 MAX HD4 / HD2 and HD4 with MediaFast

4.6.1 Panel Appearance



4.6.2 LED Indicators

The statuses indicated by the front panel LEDs are as follows:

Status Indicators		
Status	OFF	System initializing
	Red	Booting up or busy
	Blinking red	Boot up error
	Green	Ready

Wi-Fi AP and Wi-Fi WAN Indicators		
Wi-Fi WAN / Cellular 1 / Cellular 2	OFF	Disabled Intermittent
	Blinking slowly	Connecting to wireless network(s)
	Blinking	Connected to wireless network(s) with traffic
	ON	Connected to wireless network(s) without traffic

LAN and Ethernet WAN Ports

Green LED	ON	10 / 100 / 1000 Mbps
	Blinking	Data is transferring
Orange LED	OFF	No data is being transferred or port is not connected
Port Type	Auto MDI/MDI-X ports	

4.7 MAX BR1

4.7.1 Panel Appearance



MAX-BR1-LTE Version

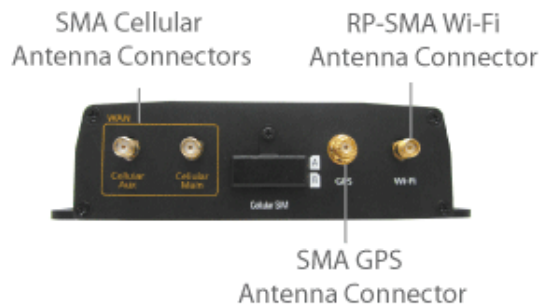

MAX-BR1 Version

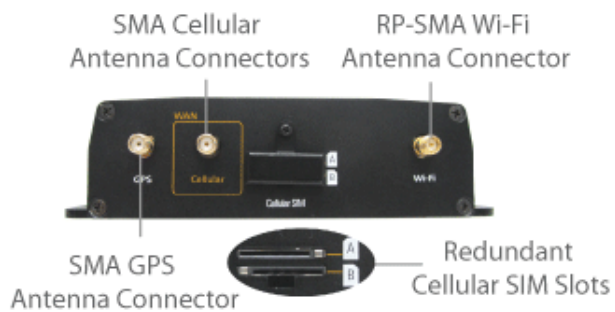
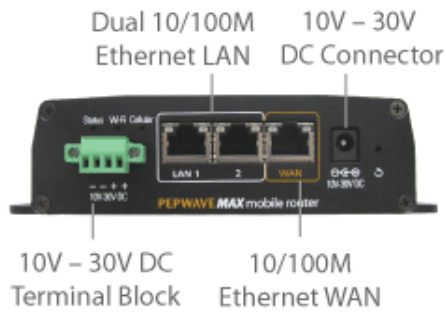

4.7.2 LED Indicators

The statuses indicated by the front panel LEDs are as follows:

Status Indicators

Status	OFF	System initializing
	Red	Booting up or busy
	Blinking red	Boot up error
	Green	Ready

Wi-Fi Indicators		
Wi-Fi	OFF	Disabled intermittent
	Blinking slowly	Connecting to wireless network(s)
	Blinking	Connected to wireless network(s) with traffic
	ON	Connected to wireless network(s) without traffic

Cellular Indicators		
Cellular	OFF	Disabled or no SIM card inserted
	ON	Connecting or connected to network(s)

LAN and Ethernet WAN Ports		
Green LED	ON	100 Mbps
	OFF	10 Mbps
Orange LED	ON	Port is connected without traffic
	Blinking	Data is transferring
Port Type	OFF	Port is not connected
	Auto MDI/MDI-X ports	

4.8 MAX BR1 Slim

4.8.1 Panel Appearance

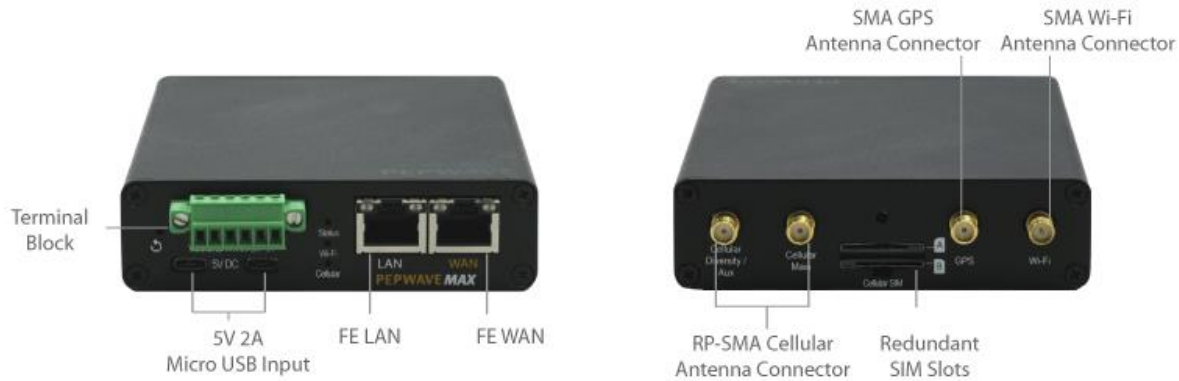

4.8.2 LED Indicators

The statuses indicated by the front panel LEDs are as follows:

Status Indicators		
Status	OFF	System initializing
	Red	Booting up or busy
	Blinking red	Boot up error
	Green	Ready

Wi-Fi Indicators		
Wi-Fi	OFF	Disabled intermittent
	Blinking slowly	Connecting to wireless network(s)
	Blinking	Connected to wireless network(s) with traffic
	ON	Connected to wireless network(s) without traffic

Cellular Indicators		
Cellular	OFF	Disabled or no SIM card inserted

ON	Connecting or connected to network(s)
----	---------------------------------------

LAN and Ethernet WAN Ports		
Green LED	ON	100 Mbps
	OFF	10 Mbps
Orange LED	ON	Port is connected without traffic
	Blinking	Data is transferring
	OFF	Port is not connected
Port Type	Auto MDI/MDI-X ports	

4.9 MAX BR1 ENT

4.9.1 Panel Appearance



4.9.2 LED Indicators

- The statuses indicated by the front panel LEDs are as follows:

Status Indicators		
Status	OFF	System initializing
	Red	Booting up or busy
	Blinking red	Boot up error
	Green	Ready

Cellular Indicators

Cellular	OFF	Disabled or no SIM card inserted
	ON	Connecting or connected to network(s)

LAN and Ethernet WAN Ports		
Green LED	ON	100 Mbps
	OFF	10 Mbps
Orange LED	ON	Port is connected without traffic
	Blinking	Data is transferring
	OFF	Port is not connected
Port Type	Auto MDI/MDI-X ports	

4.10 MAX BR1 Pro LTE

4.10.1 Panel Appearance

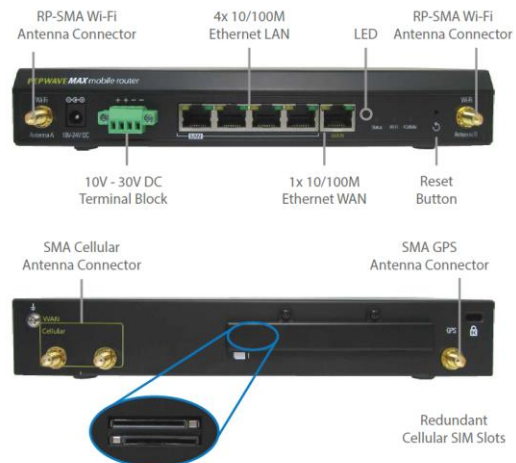
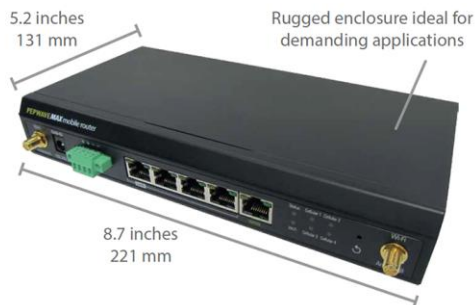

4.10.2 LED Indicators

- The statuses indicated by the front panel LEDs are as follows:

Status Indicators		
Status	OFF	System initializing
	Red	Booting up or busy
	Blinking	Boot up error

red
Green Ready

Cellular Indicators		
Cellular	OFF	Disabled or no SIM card inserted
	ON	Connecting or connected to network(s)

LAN and Ethernet WAN Ports		
Green LED	ON	100 Mbps
	OFF	10 Mbps
Orange LED	ON	Port is connected without traffic
	Blinking	Data is transferring
	OFF	Port is not connected
Port Type	Auto MDI/MDI-X ports	

4.11 MAX Hotspot

4.11.1 Panel Appearance

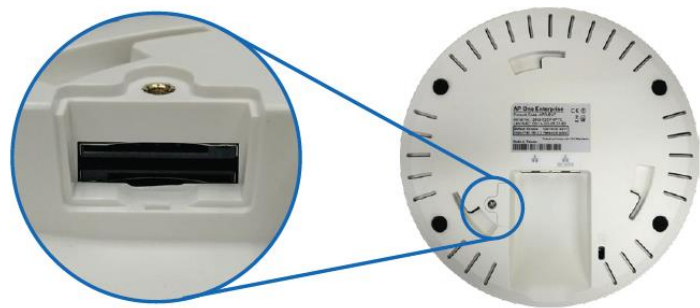
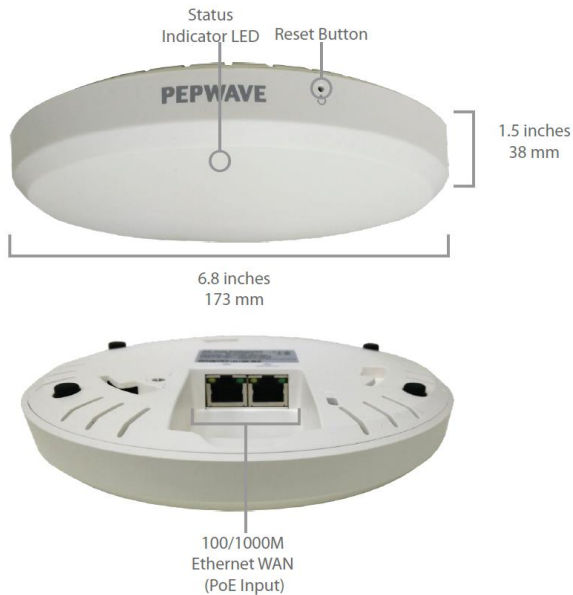

Screw Open the Panel to Reveal Redundant SIM Slots

4.11.2 LED Indicators

LAN and Ethernet WAN Ports		
Green LED	ON	10 / 100 / 1000 Mbps
	Blinking	Data is transferring
Orange LED	OFF	No data is being transferred or port is not connected
	Port Type	Auto MDI/MDI-X ports

4.12 BR1 Mini

4.12.1 Panel Appearance



4.12.2 LED Indicators

Status Indicators		
Status	OFF	System initializing
	Red	Booting up or busy
	Blinking	Boot up error

red	
Green	Ready

Cellular Indicators		
Cellular	OFF	Disabled or no SIM card inserted
	ON	Connecting or connected to network(s)

LAN and Ethernet WAN Ports		
Green LED	ON	100 Mbps
	OFF	10 Mbps
Orange LED	ON	Port is connected without traffic
	Blinking	Data is transferring
	OFF	Port is not connected
Port Type	Auto MDI/MDI-X ports	

4.13 MAX BR1/2 IP55

4.13.1 Panel Appearance

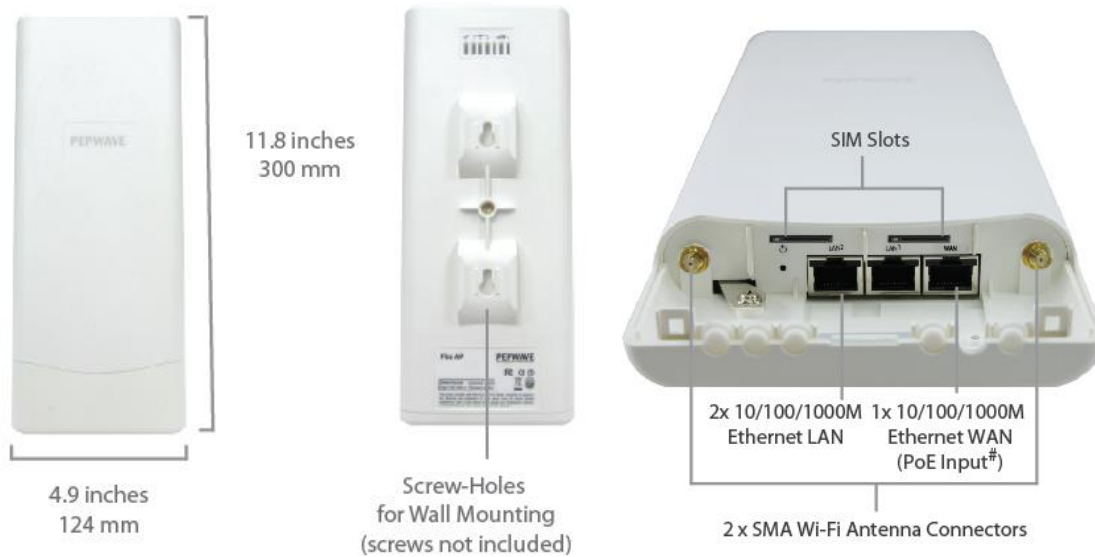

4.13.2 LED Indicators

The statuses indicated by the front panel LEDs are as follows:

Status Indicators		
Status	OFF	System initializing
	Red	Booting up or busy
	Blinking red	Boot up error
	Green	Ready

Wi-Fi Indicators		
Wi-Fi	OFF	Disabled Intermittent
	Blinking slowly	Connecting to wireless network(s)
	Blinking	Connected to wireless network(s) with traffic
	ON	Connected to wireless network(s) without traffic

Cellular Indicators		
Cellular	OFF	Disabled or no SIM card inserted
	ON	Connecting or connected to network(s)

LAN and Ethernet WAN Ports		
Green LED	ON	100 Mbps
	OFF	10 Mbps
Orange LED	ON	Port is connected without traffic
	Blinking	Data is transferring
	OFF	Port is not connected
Port Type	Auto MDI/MDI-X ports	

4.14 MAX On-The-Go

4.14.1 Panel Appearance



4.14.2 LED Indicators

The statuses indicated by the front panel LEDs are as follows:

Cellular Indicators		
WAN	OFF	Modem is not attached to the port
	Green	Modem is attached to the port

Wi-Fi Indicators		
Wi-Fi	OFF	Disconnected from AP
	Green	Connected to AP

Status Indicators		
Status	OFF	System initializing
	Red	Booting up or busy
	Green	Ready

LAN and Ethernet WAN Ports		
Green LED	ON	100 Mbps
	OFF	10 Mbps
Orange LED	ON	Port is connected without traffic

	Blinking	Data is transferring
Port Type	Auto MDI/MDI-X ports	

5 Advanced Feature Summary

5.1 Drop-in Mode and LAN Bypass: Transparent Deployment



As your organization grows, it needs more bandwidth. But modifying your network would require effort better spent elsewhere. In **Drop-in Mode**, you can conveniently install your Peplink router without making any changes to your network. And if the Peplink router loses power for any reason, **LAN Bypass** will safely and automatically bypass the Peplink router to resume your original network connection.

Compatible with: MAX 700, MAX HD2 (All variants), HD4 (All Variants)

5.2 QoS: Clearer VoIP



VoIP and videoconferencing are highly sensitive to latency. With QoS, Peplink routers can detect VoIP traffic and assign it the highest priority, giving you crystal-clear calls.

5.3 Per-User Bandwidth Control

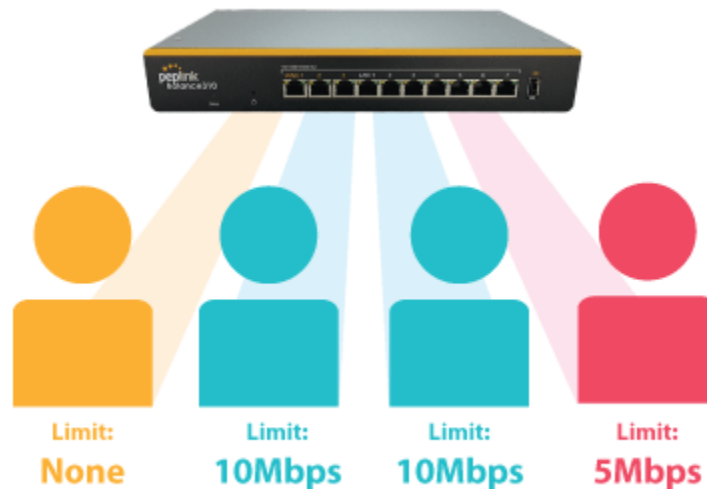

With per-user bandwidth control, you can define bandwidth control policies for up to 3 groups of users to prevent network congestion. Define groups by IP address and subnet, and set bandwidth limits for every user in the group.

5.4 High Availability via VRRP



When your organization has a corporate requirement demanding the highest availability with no single point of failure, you can deploy two Peplink routers in **High Availability mode**. With High Availability mode, the second device will take over when needed.

Compatible with: MAX 700, MAX HD2 (All variants), HD4 (All Variants)

5.5 USB Modem and Android Tethering



For increased WAN diversity, plug in a USB LTE modem as backup. Peplink routers are compatible with over [200 modem types](#). You can also tether to smartphones running Android 4.1.X and above.

Compatible with: MAX 700, HD2 (all variants except IP67), HD4 (All variants)

5.6 Built-In Remote User VPN Support



Use L2TP with IPsec to safely and conveniently connect remote clients to your private network. L2TP with IPsec is supported by most devices, but legacy devices can also connect using PPTP.

[Click here for full instructions on setting up L2TP with IPsec.](#)

5.7 SIM-card USSD support

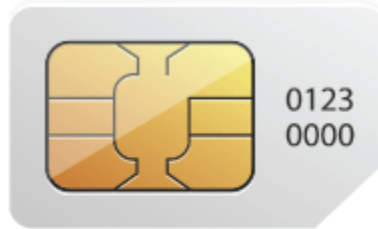

Cellular-enabled routers can now use USSD to check their SIM card's balance, process pre-paid cards, and configure carrier-specific services. [Click here for full instructions on using USSD.](#)

6 Installation

The following section details connecting Pepwave routers to your network.

6.1 Preparation

Before installing your Pepwave router, please prepare the following as appropriate for your installation:

- At least one Internet/WAN access account and/or Wi-Fi access information
- Depending on network connection type(s), one or more of the following:
 - **Ethernet WAN:** A 10/100/1000BaseT UTP cable with RJ45 connector
 - **USB:** A USB modem
 - **Embedded modem:** A SIM card for GSM/HSPA service
 - **Wi-Fi WAN:** Wi-Fi antennas

- **PC Card/Express Card WAN:** A PC Card/ExpressCard for the corresponding card slot
- A computer installed with the TCP/IP network protocol and a supported web browser. Supported browsers include Microsoft Internet Explorer 8.0 or above, Mozilla Firefox 10.0 or above, Apple Safari 5.1 or above, and Google Chrome 18 or above.

6.2 Constructing the Network

At a high level, construct the network according to the following steps:

1. With an Ethernet cable, connect a computer to one of the LAN ports on the Pepwave router. Repeat with different cables for up to 4 computers to be connected.
2. With another Ethernet cable or a USB modem/Wi-Fi antenna/PC Card/Express Card, connect to one of the WAN ports on the Pepwave router. Repeat the same procedure for other WAN ports.
3. Connect the power adapter to the power connector on the rear panel of the Pepwave router, and then plug it into a power outlet.

The following figure schematically illustrates the resulting configuration:

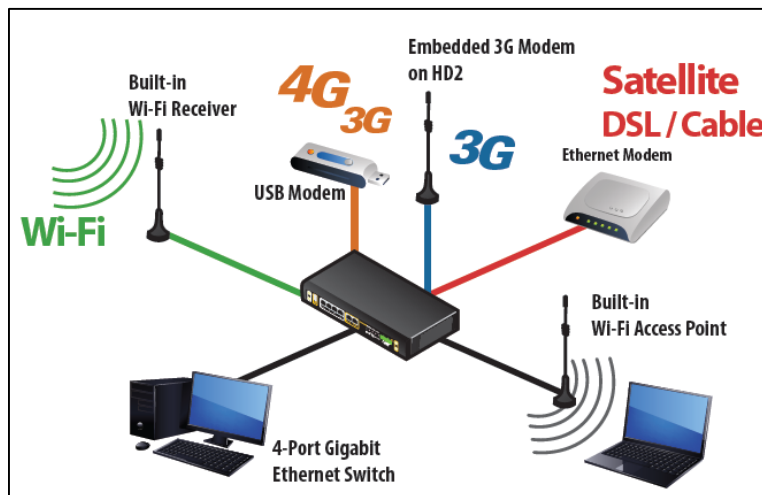

6.3 Configuring the Network Environment

To ensure that the Pepwave router works properly in the LAN environment and can access the Internet via WAN connections, please refer to the following setup procedures:

- LAN configuration
For basic configuration, refer to **Section 8, Connecting to the Web Admin Interface**.
For advanced configuration, go to **Section 9, Configuring the LAN Interface(s)**.
- WAN configuration
For basic configuration, refer to **Section 8, Connecting to the Web Admin Interface**.
For advanced configuration, go to **Section 9.2, Captive Portal**.

7 Mounting the Unit

7.1 Wall Mount

The Pepwave MAX 700/HD2/On-The-Go can be wall mounted using screws. After adding the screw on the wall, slide the MAX in the screw hole socket as indicated below. Recommended screw specification: M3.5 x 20mm, head diameter 6mm, head thickness 2.4mm.

The Pepwave MAX BR1 requires four screws for wall mounting.

7.2 Car Mount

The Pepwave MAX700/HD2 can be mounted in a vehicle using the included mounting brackets. Place the mounting brackets by the two sides and screw them onto the device.



7.3 IP67 Installation Guide

Installation instructions for IP67 devices can be found here:
http://download.peplink.com/manual/IP67_Installation_Guide.pdf

8 Connecting to the Web Admin Interface

1. Start a web browser on a computer that is connected with the Pepwave router through the LAN.
2. To connect to the router's web admin interface, enter the following LAN IP address in the address field of the web browser:

`http://192.168.50.1`

(This is the default LAN IP address for Pepwave routers.)

3. Enter the following to access the web admin interface.

Username: admin

Password: admin

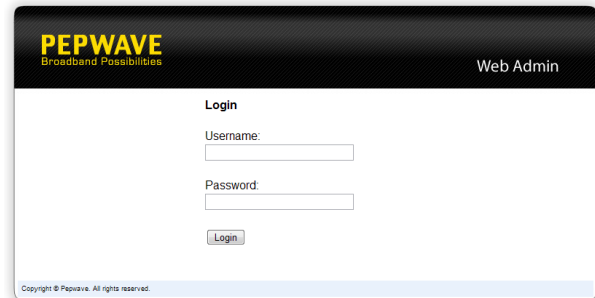

*(This is the default username and password for Pepwave routers. The admin and read-only user passwords can be changed at **System>Admin Security**.)*

4. After successful login, the **Dashboard** will be displayed

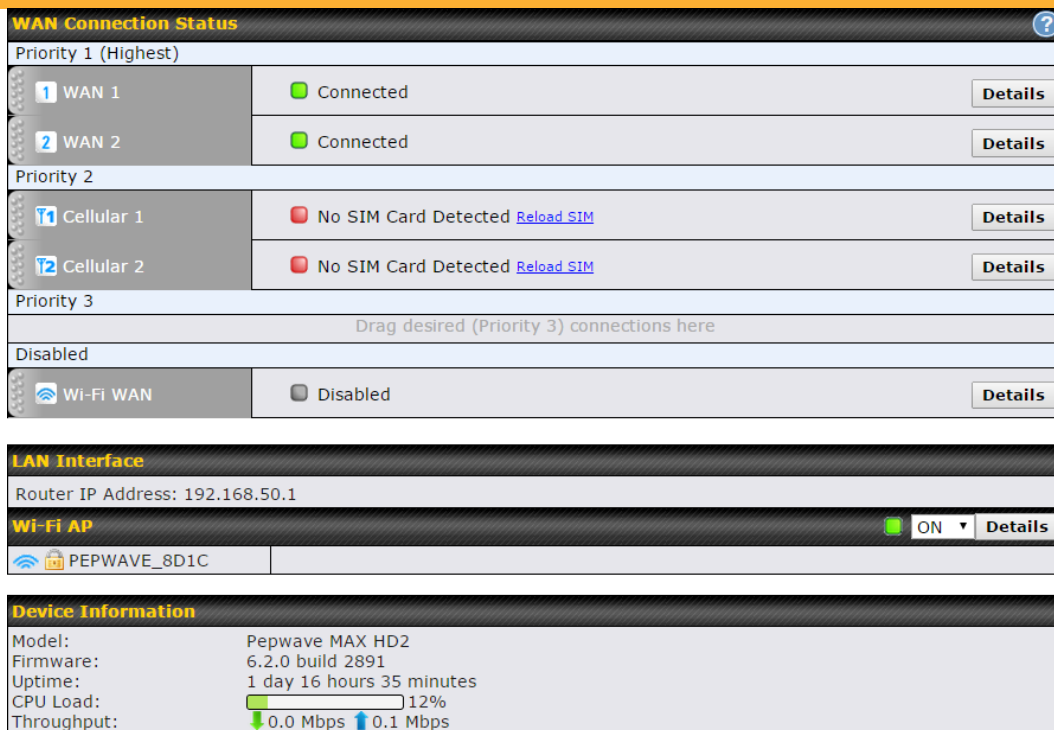

WAN Connection Status

Priority 1 (Highest)

1 WAN 1	Connected	Details
2 WAN 2	Connected	Details

Priority 2

1 Cellular 1	No SIM Card Detected Reload SIM	Details
2 Cellular 2	No SIM Card Detected Reload SIM	Details

Priority 3

Drag desired (Priority 3) connections here

Disabled

Wi-Fi WAN	Disabled	Details
-----------	----------	---------

LAN Interface

Router IP Address: 192.168.50.1

Wi-Fi AP ON Details

PEPWAVE_8D1C

Device Information

Model:	Pepwave MAX HD2
Firmware:	6.2.0 build 2891
Uptime:	1 day 16 hours 35 minutes
CPU Load:	12%
Throughput:	↓ 0.0 Mbps ↑ 0.1 Mbps

The **Dashboard** shows current WAN, LAN, and Wi-Fi AP statuses. Here, you can change WAN connection priority and switch on/off the Wi-Fi AP. For further information on setting up these connections, please refer to **Sections 8** and **9**.

Device Information displays details about the device, including model name, firmware version, and uptime. For further information, please refer to **Section 22**.

Important Note

Configuration changes (e.g. WAN, LAN, admin settings, etc.) will take effect only after clicking the **Save** button at the bottom of each page. The **Apply Changes** button causes the changes to be saved and applied.

9 Configuring the LAN Interface(s)

9.1 Basic Settings

LAN interface settings are located at **Network>LAN>Network Settings**. Navigating to that page will result in the following dashboard:

LAN	VLAN	Network	
LAN	None	172.16.251.1/24	
VLAN1	1	2.2.2.2/24	X
VLAN2	2	3.3.3.3/24	X

New LAN

This represents the LAN interfaces that are active on your router (including VLAN). A grey “X” means that the VLAN is used in other settings and cannot be deleted. You can find which settings are using the VLAN by hovering over the grey “X”.

Alternatively, a red “X” means that there are no settings using the VLAN. You can delete that VLAN by clicking the red “X”

Clicking any of the existing LAN interfaces (or creating a new one) will result in the following

IP Settings ?

IP Address

IP Settings

IP Address	The IP address and subnet mask of the Pepwave router on the LAN.
-------------------	--

Network Settings ?

Name

VLAN ID

Inter-VLAN routing

Captive Portal

Network Settings

Name	Enter a name for the LAN.
VLAN ID	Enter a number for your VLAN.
Inter-VLAN routing	Check this box to enable routing between virtual LANs.
Captive Portal	Check this box to turn on captive portals.

Drop-In Mode Settings ?	
Enable	<input checked="" type="checkbox"/>
WAN for Drop-In Mode ?	WAN 1 ▼
Share Drop-In IP ?	<input checked="" type="checkbox"/>
Shared IP Address ?	<input type="text"/> 255.255.255.0 (/24) ▼
WAN Default Gateway ?	<input type="text"/> <input checked="" type="checkbox"/> I have other host(s) on WAN segment Host IP Address(es) <input type="text"/> - <input type="text"/> <div style="text-align: center;">↓</div> <div style="border: 1px solid #ccc; height: 40px; width: 100%;"></div> <div style="text-align: right;"><input type="button" value="Delete"/></div>
WAN DNS Servers ?	DNS server 1: <input type="text"/> DNS server 2: <input type="text"/>
<p>NOTE: The DHCP Server Settings will be overwritten.</p> <p>The following WAN 1 settings will be overwritten: Connection Method, MTU, Health Check, Additional Public IP, and Dynamic DNS Settings.</p> <p>The PPTP Server will be disabled.</p> <p>Tip: please review the DNS Forwarding setting under the Service Forwarding section.</p>	

Drop-in Mode Settings	
Enable	Drop-in mode eases the installation of Peplink routers on a live network between the existing firewall and router, such that no configuration changes are required on existing equipment. Check the box to enable the drop-in mode feature, if available on your model.
WAN for Drop-In Mode	Select the WAN port to be used for drop-in mode. If WAN 1 with LAN Bypass is selected, the high availability feature will be disabled automatically.
Share Drop-In IP^A	When this option is enabled, the passthrough IP address will be used to connect to WAN hosts (email notification, remote syslog, etc.). The Pepwave router will listen for this IP address when WAN hosts access services provided by the Pepwave router (web admin access from the WAN, DNS server requests, etc.). To connect to hosts on the LAN (email notification, remote syslog, etc.), the default gateway address will be used. The Pepwave router will listen for this IP address when LAN hosts access services provided by the Pepwave router (web admin access from the WAN, DNS proxy, etc.).
Shared IP Address^A	Access to this IP address will be passed through to the LAN port if this device is not serving the service being accessed. The shared IP address will be used in connecting to hosts on the WAN (email notification, remote syslog, etc.) The device will also listen on the IP address when hosts on the WAN access services served on this device (web admin access from the WAN, DNS server, etc.)
WAN Default Gateway	Enter the WAN router's IP address in this field. If there are more hosts in addition to the router on the WAN segment, check the I have other host(s) on WAN segment box and enter the IP address of the hosts that need to access LAN devices or be accessed by others.
WAN DNS Servers	Enter the selected WAN's corresponding DNS server IP addresses.

^A - Advanced feature, please click the button on the top right-hand corner to activate.

Layer 2 PepVPN Bridging	
PepVPN Profiles to Bridge	Connection 1
Spanning Tree Protocol	<input checked="" type="checkbox"/>
Override IP Address when bridge connected	<input checked="" type="radio"/> Do not override <input type="radio"/> Static <input type="radio"/> By DHCP <input type="radio"/> As None

Layer 2 PepVPN Bridging

PepVPN Profiles to Bridge	The remote network of the selected PepVPN profiles will be bridged with this local LAN, creating a Layer 2 PepVPN, they will be connected and operate like a single LAN, and any broadcast or multicast packets will be sent over the VPN.
Spanning Tree Protocol	Click the box will enable STP for this layer 2 profile bridge.
Override IP Address when bridge connected	<p>Select "Do not override" if the LAN IP address and local DHCP server should remain unchanged after the Layer 2 PepVPN is up.</p> <p>If you choose to override IP address when the VPN is connected, the device will not act as a router, and most Layer 3 routing functions will cease to work.</p>

DHCP Server Settings											
DHCP Server	<input checked="" type="checkbox"/>	Enable									
IP Range	<input type="text" value="192.168.50.10"/>	-	<input type="text" value="192.168.50.250"/>								
Subnet Mask	<input type="text" value="255.255.255.0"/>	(/24)									
Lease Time	<input type="text" value="1"/>	Days	<input type="text" value="0"/>								
		Hours	<input type="text" value="0"/>								
		Mins	<input type="text" value="0"/>								
DNS Servers	<input checked="" type="checkbox"/>	Assign DNS server automatically									
WINS Server	<input checked="" type="checkbox"/>	Assign WINS server									
	<input checked="" type="radio"/>	Built-in									
	<input type="radio"/>	External									
BOOTP	<input checked="" type="checkbox"/>	Server IP Address: <input type="text"/>									
		Boot File: <input type="text"/>									
		Server Name: <input type="text"/> (Optional)									
Extended DHCP Option	<input type="checkbox"/>	<table border="1"> <thead> <tr> <th>Option</th> <th>Value</th> </tr> </thead> <tbody> <tr> <td colspan="2" style="text-align: center;"><i>No Extended DHCP Option</i></td> </tr> <tr> <td colspan="2" style="text-align: center;"><input type="button" value="Add"/></td> </tr> </tbody> </table>		Option	Value	<i>No Extended DHCP Option</i>		<input type="button" value="Add"/>			
Option	Value										
<i>No Extended DHCP Option</i>											
<input type="button" value="Add"/>											
DHCP Reservation	<input type="checkbox"/>	<table border="1"> <thead> <tr> <th>Name</th> <th>MAC Address</th> <th>Static IP</th> <th></th> </tr> </thead> <tbody> <tr> <td></td> <td></td> <td></td> <td style="text-align: center;"><input type="button" value="+"/></td> </tr> </tbody> </table>		Name	MAC Address	Static IP					<input type="button" value="+"/>
Name	MAC Address	Static IP									
			<input type="button" value="+"/>								

DHCP Server Settings	
DHCP Server	When this setting is enabled, the DHCP server automatically assigns an IP address to each computer that is connected via LAN and configured to obtain an IP address via DHCP. The Pepwave router's DHCP server can prevent IP address collision on the LAN.
IP Range & Subnet Mask	These settings allocate a range of IP addresses that will be assigned to LAN computers by the Pepwave router's DHCP server.
Lease Time	This setting specifies the length of time throughout which an IP address of a DHCP client remains valid. Upon expiration of the lease time, the assigned IP address will no longer be valid and renewal of the IP address assignment will be required.

DNS Servers

This option allows you to input the DNS server addresses to be offered to DHCP clients. If **Assign DNS server automatically** is selected, the Pepwave router's built-in DNS server address (i.e., LAN IP address) will be offered.

WINS Server

This option allows you to optionally specify a Windows Internet Name Service (WINS) server. You may choose to use the **built-in WINS server** or **external WINS servers**.
When this unit is connected using SpeedFusion™, other VPN peers can share this unit's built-in WINS server by entering this unit's LAN IP address in their DHCP **WINS Server** setting. Afterward, all PC clients in the VPN can resolve the NetBIOS names of other clients in remote peers. If you have enabled this option, a list of WINS clients will be displayed at **Status>WINS Clients**.

BOOTP

Check this box to enable BOOTP on older networks that still require it.



Extended DHCP Option

In addition to standard DHCP options (e.g., DNS server address, gateway address, subnet mask), you can specify the value of additional extended DHCP options, as defined in RFC 2132. With these extended options enabled, you can pass additional configuration information to LAN hosts.

To define an extended DHCP option, click the **Add** button, choose the option to define and enter its value. For values that are in IP address list format, you can enter one IP address per line in the provided text area input control. Each option can be defined once only.

DHCP Reservation

This setting reserves the assignment of fixed IP addresses for a list of computers on the LAN. The computers to be assigned fixed IP addresses on the LAN are identified by their MAC addresses. The fixed IP address assignment is displayed as a cross-reference list between the computers' names, MAC addresses, and fixed IP addresses.

Name (an optional field) allows you to specify a name to represent the device. MAC addresses should be in the format of **00:AA:BB:CC:DD:EE**. Press  to create a new record. Press  to remove a record. Reserved client information can be imported from the **Client List**, located at **Status>Client List**. For more details, please refer to **Section 22.3**.



LAN Physical Settings

Speed

This is the port speed of the LAN interface. It should be set to the same speed as the connected device to avoid port negotiation problems. When a static speed is set, you may choose whether to advertise its speed to the peer device. **Auto** is selected by default. You can choose not to advertise the port speed if the port has difficulty negotiating with the peer device.

Static Route Settings			
Static Route		Destination Network	Subnet Mask
			255.255.255.0 (/24) ▼
		Gateway	

Static Route Settings

Static Route

This table is for defining static routing rules for the LAN segment. A static route consists of the network address, subnet mask, and gateway address. The address and subnet mask values are in w.x.y.z format.

The local LAN subnet and subnets behind the LAN will be advertised to the VPN. Remote routes sent over the VPN will also be accepted. Any VPN member will be able to route to the local subnets. Press to create a new route. Press to remove a route.

WINS Server Settings	
Enable	<input type="checkbox"/>



WINS Server Settings

Enable

Check the box to enable the WINS server. A list of WINS clients will be displayed at **Status>WINS Clients**.

DNS Proxy Settings																
Enable	<input checked="" type="checkbox"/>															
DNS Caching		<input type="checkbox"/>														
Include Google Public DNS Servers		<input type="checkbox"/>														
Local DNS Records		<table border="1"> <thead> <tr> <th>Host Name</th> <th>IP Address</th> <th></th> </tr> </thead> <tbody> <tr> <td> </td> <td> </td> <td> </td> </tr> </tbody> </table>	Host Name	IP Address												
Host Name	IP Address															
DNS Resolvers		<table border="1"> <thead> <tr> <th>Connection</th> <th>Current Status</th> </tr> </thead> <tbody> <tr> <td><input type="checkbox"/> WAN 1</td> <td>10.88.3.1</td> </tr> <tr> <td><input type="checkbox"/> WAN 2</td> <td> </td> </tr> <tr> <td><input type="checkbox"/> Wi-Fi WAN</td> <td> </td> </tr> <tr> <td><input type="checkbox"/> Cellular 1</td> <td> </td> </tr> <tr> <td><input type="checkbox"/> Cellular 2</td> <td> </td> </tr> <tr> <td><input type="checkbox"/> USB</td> <td> </td> </tr> </tbody> </table>	Connection	Current Status	<input type="checkbox"/> WAN 1	10.88.3.1	<input type="checkbox"/> WAN 2		<input type="checkbox"/> Wi-Fi WAN		<input type="checkbox"/> Cellular 1		<input type="checkbox"/> Cellular 2		<input type="checkbox"/> USB	
		Connection	Current Status													
		<input type="checkbox"/> WAN 1	10.88.3.1													
		<input type="checkbox"/> WAN 2														
		<input type="checkbox"/> Wi-Fi WAN														
		<input type="checkbox"/> Cellular 1														
		<input type="checkbox"/> Cellular 2														
<input type="checkbox"/> USB																
<table border="1"> <thead> <tr> <th>Connection</th> <th>DNS Servers</th> </tr> </thead> <tbody> <tr> <td><input type="checkbox"/> LAN</td> <td> </td> </tr> <tr> <td> </td> <td> </td> </tr> </tbody> </table>	Connection	DNS Servers	<input type="checkbox"/> LAN													
Connection	DNS Servers															
<input type="checkbox"/> LAN																
Preferred connections are shown with <input checked="" type="checkbox"/>																



DNS Proxy Settings

Enable	To enable the DNS proxy feature, check this box, and then set up the feature at Network>LAN>DNS Proxy Settings . A DNS proxy server can be enabled to serve DNS requests originating from LAN/PPTP/SpeedFusion™ peers. Requests are forwarded to the DNS servers/resolvers defined for each WAN connection.
DNS Caching	This field is to enable DNS caching on the built-in DNS proxy server. When the option is enabled, queried DNS replies will be cached until the records' TTL has been reached. This feature can help improve DNS lookup time. However, it cannot return the most up-to-date result for those frequently updated DNS records. By default, DNS Caching is disabled.
Include Google Public DNS Servers	When this option is enabled , the DNS proxy server will also forward DNS requests to Google's Public DNS Servers, in addition to the DNS servers defined in each WAN. This could increase the DNS service's availability. This setting is disabled by default.
Local DNS Records	This table is for defining custom local DNS records. A static local DNS record consists of a host name and IP address. When looking up the host name from the LAN to LAN IP of the Pepwave router, the corresponding IP address will be returned. Press  to create a new record. Press  to remove a record.
DNS Resolvers ^A	Check the box to enable the WINS server. A list of WINS clients will be displayed at Network>LAN>DNS Proxy Settings>DNS Resolvers . This field specifies which DNS resolvers will receive forwarded DNS requests. If no WAN/VPN/LAN DNS resolver is selected, all of the WAN's DNS resolvers will be selected. If a SpeedFusion™ peer is selected, you may enter the VPN peer's DNS resolver IP address(es). Queries will be forwarded to the selected connections' resolvers. If all of the selected connections are down, queries will be forwarded to all resolvers on healthy WAN connections.

^A - Advanced feature, please click the  button on the top right hand corner to activate.

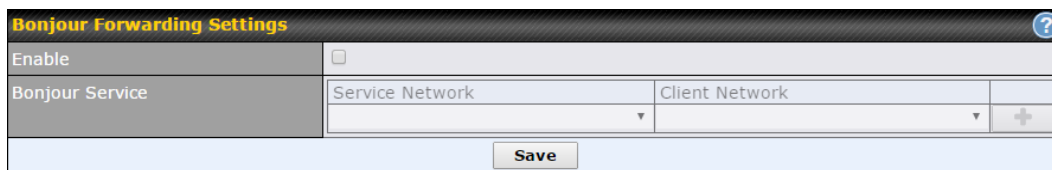
Finally, if needed, configure Bonjour forwarding, Apple's zero configuration networking protocol. Once VLAN configuration is complete, click **Save** to store your changes.



Bonjour Forwarding Settings	
Enable	Check this box to turn on Bonjour forwarding.
Bonjour Service	Choose Service and Client networks from the drop-down menus, and then click  to add the networks. To delete an existing Bonjour listing, click  .

To enable VLAN configuration, click the button in the **IP Settings** section.

The screenshot shows the 'IP Settings' header with a help icon on the right. Below it, there are two input fields: 'IP Address' containing '192.168.50.1' and a dropdown menu showing '255.255.255.0 (/24)'.

To add a new LAN, click the **New LAN** button. To change LAN settings, click the name of the LAN to change under the **LAN** heading.

The screenshot shows a table with columns 'LAN', 'VLAN', and 'Network'. The first row has 'Untagged LAN', 'None', and '192.168.50.1/24'. Below the table is a 'New LAN' button. An orange arrow points to the 'Untagged LAN' text.

The following settings are displayed when creating a new LAN or editing an existing LAN.

A dark grey header bar with the word 'LAN' in yellow on the left and a close button (X) on the right.

The 'IP Settings' form with an empty 'IP Address' field and a dropdown menu set to '255.255.255.0 (/24)'. A help icon is visible in the top right corner.

IP Settings	
IP Address & Subnet Mask	Enter the Pepwave router's IP address and subnet mask values to be used on the LAN.

The 'Network Settings' form with fields for 'Name', 'VLAN ID', 'Inter-VLAN routing' (checked), and 'Captive Portal' (unchecked). A help icon is visible in the top right corner.

Network Settings	
Name	Enter a name for the LAN.
VLAN ID	Enter a number for your VLAN.

Inter-VLAN routing

Check this box to enable routing between virtual LANs.

Captive Portal

Check this box to turn on captive portals.

DHCP Server Settings			
DHCP Server		<input checked="" type="checkbox"/> Enable	
IP Range		<input type="text"/> - <input type="text"/>	255.255.255.0 (/24) ▾
Lease Time		1 Days 0 Hours 0 Mins	
DNS Servers		<input checked="" type="checkbox"/> Assign DNS server automatically	
WINS Servers		<input type="checkbox"/> Assign WINS server	
BOOTP		<input type="checkbox"/>	
Extended DHCP Option		Option	Value
		<i>No Extended DHCP Option</i>	
		<input type="button" value="Add"/>	
DHCP Reservation		Name	MAC Address
			Static IP
			<input type="button" value="+"/>

DHCP Server Settings

DHCP Server

When this setting is enabled, the Pepwave router's DHCP server automatically assigns an IP address to each computer that is connected via LAN and configured to obtain an IP address via DHCP. The Pepwave router's DHCP server can prevent IP address collisions on the LAN.

To enable DHCP bridge relay, please click the icon on this menu item.

IP Range & Subnet Mask

These settings allocate a range of IP address that will be assigned to LAN computers by the Pepwave router's DHCP server.

Lease Time

This setting specifies the length of time throughout which an IP address of a DHCP client remains valid. Upon expiration of **Lease Time**, the assigned IP address will no longer be valid and the IP address assignment must be renewed.

DNS Servers

This option allows you to input the DNS server addresses to be offered to DHCP clients. If **Assign DNS server automatically** is selected, the Pepwave router's built-in DNS server address (i.e., LAN IP address) will be offered.

WINS Servers

This option allows you to specify the Windows Internet Name Service (WINS) server. You may choose to use the built-in WINS server or external WINS servers. When this unit is connected using SpeedFusion™, other VPN peers can share this unit's built-in WINS server by entering this unit's LAN IP address in their **DHCP WINS Servers** setting. Therefore, all PC clients in the VPN can resolve the NetBIOS names of other clients in remote peers. If you have enabled this option, a list of WINS clients will be displayed at **Status>WINS Clients**.

BOOTP	Check this box to enable BOOTP on older networks that still require it.
Extended DHCP Option	In addition to standard DHCP options (e.g. DNS server address, gateway address, subnet mask), you can specify the value of additional extended DHCP options, as defined in RFC 2132. With these extended options enabled, you can pass additional configuration information to LAN hosts. To define an extended DHCP option, click the Add button, choose the option to define, and then enter its value. For values that are in IP address list format, you can enter one IP address per line in the provided text area input control. Each option can be defined once only.
DHCP Reservation	This setting reserves the assignment of fixed IP addresses for a list of computers on the LAN. The computers to be assigned fixed IP addresses on the LAN are identified by their MAC addresses. The fixed IP address assignment is displayed as a cross-reference list between the computers' names, MAC addresses, and fixed IP addresses. Name (an optional field) allows you to specify a name to represent the device. MAC addresses should be in the format of 00:AA:BB:CC:DD:EE . Press to create a new record. Press to remove a record. Reserved clients information can be imported from the Client List , located at Status>Client List . For more details, please refer to Section 22.3 .

To configure DHCP relay, first click the button found next to the **DHCP Server** option to display the settings.

DHCP Relay Settings	
Enable	Check this box to turn on DHCP relay. Click the icon to disable DHCP relay.
DHCP Server IP Address	Enter the IP addresses of one or two DHCP servers in the provided fields. The DHCP servers entered here will receive relayed DHCP requests from the LAN. For active-passive DHCP server configurations, enter active and passive DHCP server relay IP addresses in DHCP Server 1 and DHCP Server 2 .
DHCP Option 82	DCHP Option 82 includes device information as relay agent for the attached client when forwarding DHCP requests from client to server. This option also embeds the device's MAC address and network name in circuit and remote IDs. Check this box to enable DHCP Option 82.

Once DHCP is set up, configure **LAN Physical Settings**, **Static Route Settings**, **WINS Server Settings**, and **DNS Proxy Settings** as noted above.

9.2 Port Settings

To configure port settings, navigate to **Network > Port Settings**

Port Settings					
Port Name	Enable	Speed	Advertise Speed	Port Type	VLAN
LAN Port 1	<input checked="" type="checkbox"/>	Auto	<input checked="" type="checkbox"/>	Trunk	Any
LAN Port 2	<input checked="" type="checkbox"/>			Trunk	Any
LAN Port 3	<input checked="" type="checkbox"/>			Trunk	Any
LAN Port 4	<input checked="" type="checkbox"/>			Trunk	Any

On this screen, you can enable specific ports, as well as determine the speed of the LAN ports, whether each port is a trunk or access port, can well as which VLAN each link belongs to, if any.

9.3 Captive Portal

The captive portal serves as gateway that clients have to pass if they wish to access the internet using your router. To configure, navigate to **Network>LAN>Captive Portal**.

Captive Portal Settings	
Enable	<input checked="" type="checkbox"/> Untagged LAN
Hostname	<input type="text" value="captive-portal.peplink.com"/> Default
Access Mode	<input checked="" type="radio"/> Open Access <input type="radio"/> User Authentication
Access Quota	30 mins (0: Unlimited) 0 MB (0: Unlimited)
Quota Reset Time	<input checked="" type="radio"/> Daily at 00 :00 <input type="radio"/> 1440 minutes after quota reached
Allowed Networks	<input type="text" value="Domain Name / IP Address"/> +
Allowed Clients	<input type="text" value="MAC / IP Address"/> +
Splash Page	<input checked="" type="radio"/> Built-in <input type="radio"/> External, URL: <input type="text" value="http://"/>

Captive Portal Settings

Enable

Check **Enable** and then, optionally, select the LANs/VLANs that will use the captive portal.

Hostname	To customize the portal's form submission and redirection URL, enter a new URL in this field. To reset the URL to factory settings, click Default .																												
Access Mode	Click Open Access to allow clients to freely access your router. Click User Authentication to force your clients to authenticate before accessing your router.																												
RADIUS Server	<p>This authenticates your clients through a RADIUS server. After selecting this option, you will see the following fields:</p> <table border="1" data-bbox="440 489 1263 684"> <tr> <td>Authentication</td> <td colspan="3">RADIUS Server ▼</td> </tr> <tr> <td>Auth Server</td> <td><input type="text"/></td> <td>Port 1812</td> <td>Default</td> </tr> <tr> <td>Auth Server Secret</td> <td><input type="text"/></td> <td><input checked="" type="checkbox"/> Hide Characters</td> <td></td> </tr> <tr> <td>CoA-DM</td> <td colspan="3"><input type="checkbox"/></td> </tr> <tr> <td>Accounting Server</td> <td><input type="text"/></td> <td>Port 1813</td> <td>Default</td> </tr> <tr> <td>Accounting Server Secret</td> <td><input type="text"/></td> <td><input checked="" type="checkbox"/> Hide Characters</td> <td></td> </tr> <tr> <td>Accounting Interim Interval</td> <td><input type="text"/></td> <td>seconds</td> <td></td> </tr> </table> <p>Fill in the necessary information to complete your connection to the server and enable authentication.</p>	Authentication	RADIUS Server ▼			Auth Server	<input type="text"/>	Port 1812	Default	Auth Server Secret	<input type="text"/>	<input checked="" type="checkbox"/> Hide Characters		CoA-DM	<input type="checkbox"/>			Accounting Server	<input type="text"/>	Port 1813	Default	Accounting Server Secret	<input type="text"/>	<input checked="" type="checkbox"/> Hide Characters		Accounting Interim Interval	<input type="text"/>	seconds	
Authentication	RADIUS Server ▼																												
Auth Server	<input type="text"/>	Port 1812	Default																										
Auth Server Secret	<input type="text"/>	<input checked="" type="checkbox"/> Hide Characters																											
CoA-DM	<input type="checkbox"/>																												
Accounting Server	<input type="text"/>	Port 1813	Default																										
Accounting Server Secret	<input type="text"/>	<input checked="" type="checkbox"/> Hide Characters																											
Accounting Interim Interval	<input type="text"/>	seconds																											
LDAP Server	<p>This authenticates your clients through a LDAP server. Upon selecting this option, you will see the following fields:</p> <table border="1" data-bbox="440 882 1263 1035"> <tr> <td>Authentication</td> <td colspan="3">LDAP Server ▼</td> </tr> <tr> <td>LDAP Server</td> <td><input type="text"/></td> <td>Port 389</td> <td>Default</td> </tr> <tr> <td></td> <td colspan="3"><input type="checkbox"/> Use DN/Password to bind to LDAP Server</td> </tr> <tr> <td>Base DN</td> <td colspan="3"><input type="text"/></td> </tr> <tr> <td>Base Filter</td> <td colspan="3"><input type="text"/></td> </tr> </table> <p>Fill in the necessary information to complete your connection to the server and enable authentication.</p>	Authentication	LDAP Server ▼			LDAP Server	<input type="text"/>	Port 389	Default		<input type="checkbox"/> Use DN/Password to bind to LDAP Server			Base DN	<input type="text"/>			Base Filter	<input type="text"/>										
Authentication	LDAP Server ▼																												
LDAP Server	<input type="text"/>	Port 389	Default																										
	<input type="checkbox"/> Use DN/Password to bind to LDAP Server																												
Base DN	<input type="text"/>																												
Base Filter	<input type="text"/>																												
Access Quota	Set a time and data cap to each user's Internet usage.																												
Quota Reset Time	This menu determines how your usage quota resets. Setting it to Daily will reset it at a specified time every day. Setting a number of minutes after quota reached establish a timer for each user that begins after the quota has been reached.																												
Allowed Networks	To whitelist a network, enter the domain name / IP address here and click . To delete an existing network from the list of allowed networks, click the button next to the listing.																												
Splash Page	Here, you can choose between using the Pepwave router's built-in captive portal and redirecting clients to a URL you define.																												

The **Portal Customization** menu has two options: **Preview** and . Clicking **Preview** displays a pop-up previewing the captive portal that your clients will see. Clicking displays the following menu:

Portal Customization	
Logo Image	<input checked="" type="radio"/> No Image [Use default Logo Image] <input type="radio"/> Choose File No file chosen <small>NOTE: Size max 512KB. Supported images types: JPEG, PNG and GIF.</small>
Message	<div style="border: 1px solid #ccc; height: 100px;"></div>
Terms & Conditions	<div style="border: 1px solid #ccc; height: 100px;">[Use default Terms & Conditions]</div>
Custom Landing Page	<input checked="" type="checkbox"/> <input type="text" value="http://"/>

Portal Customization	
Logo Image	Click the Choose File button to select a logo to use for the built-in portal.
Message	If you have any additional messages for your users, enter them in this field.
Terms & Conditions	If you would like to use your own set of terms and conditions, please enter them here. If left empty, the built-in portal will display the default terms and conditions.
Custom	Fill in this field to redirect clients to an external URL.

Landing Page

10 Configuring the WAN Interface(s)

WAN Interface settings are located at **Network>WAN**. To reorder WAN priority, drag on the appropriate WAN by holding the left mouse button, move it to the desired priority (the first one would be the highest priority, the second one would be lower priority, and so on), and drop it by releasing the mouse button.

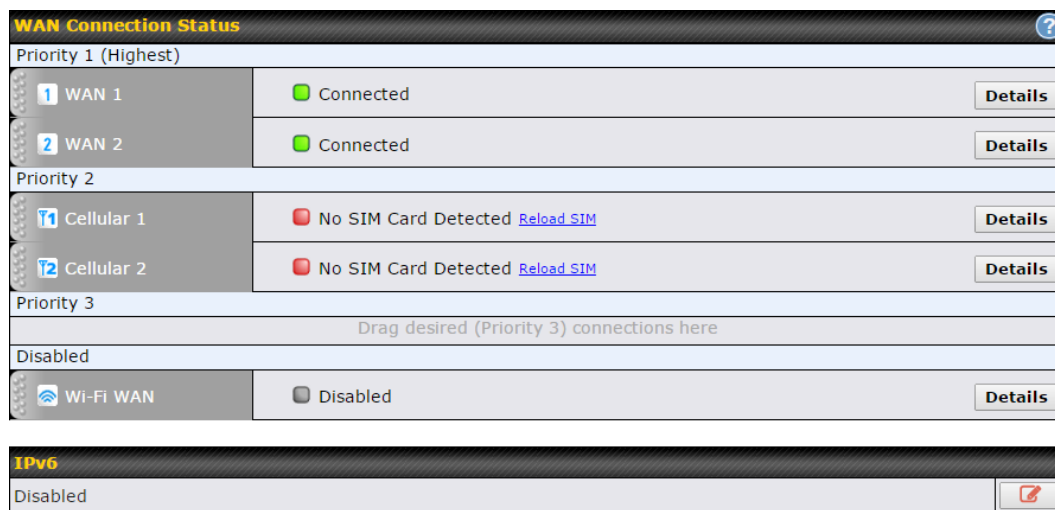

To disable a particular WAN connection, drag on the appropriate WAN by holding the left mouse button, move it the **Disabled** row, and drop it by releasing the mouse button. You can also set priorities on the **Dashboard**. Click the **Details** button in the corresponding row to modify the connection setting.

Important Note

Connection details will be changed and become effective immediately after clicking the **Save and Apply** button.

10.1 Ethernet WAN

Health Check Settings	
Health Check Method	? PING ▾
PING Hosts	? Host 1: <input type="text" value="8.8.8.8"/> Host 2: <input type="text"/> <input type="checkbox"/> Use first two DNS servers as PING Hosts
Timeout	? 5 ▾ second(s)
Health Check Interval	? 5 ▾ second(s)
Health Check Retries	? 3 ▾
Recovery Retries	? 3 ▾

Health Check Settings	
Health Check Method	<p>This field specifies the Health Check method to be used for this WAN connection.</p> <ul style="list-style-type: none"> • Disabled - The WAN connection is always considered to be up and will not be treated as down for any IP routing errors. • PING - ICMP PING packets will be issued to test connectivity with configurable target IP addresses or host names. • DNS Lookup - DNS lookups will be issued to test the connectivity with configurable target DNS server IP addresses. • HTTP - HTTP connections will be issued to test the connectivity with configurable URLs and strings to match. <p>Default: DNS Lookup</p>
PING Hosts	<p>These fields are for specifying the target IP addresses or host names where ICMP Ping packets will be sent to for health check.</p> <p>If the box Use first two DNS servers as PING Hosts is checked, the first two DNS servers will be the ping targets for checking the connection healthiness. If the box is not checked, the field Host 1 must be filled and the field Host 2 is optional.</p> <p>The connection is considered to be up if ping responses are received from any one of the ping hosts.</p>
Timeout	<p>If a health check test cannot be completed within the specified amount of time, the test will be treated as failed.</p>
Health Check Interval	<p>This is the time interval between each health check test.</p>

Health Check Retries	This is the number of consecutive check failures before treating a connection as down.
Recovery Retries	This is the number of responses required after a health check failure before treating a connection as up again.

Bandwidth Allowance Monitor Settings	
Bandwidth Allowance Monitor	<input checked="" type="checkbox"/> Enable
Action	Email notification is currently disabled. You can get notified when usage hits 75%/95% of monthly allowance by enabling Email Notification . <input checked="" type="checkbox"/> Disconnect when usage hits 100% of monthly allowance
Start Day	On <input type="text" value="1st"/> of each month at 00:00 midnight
Monthly Allowance	<input type="text"/> MB

Bandwidth Allowance Monitor Settings	
Bandwidth Allowance Monitor	Check the box <i>Enable</i> to enable bandwidth usage monitoring on this WAN connection for each billing cycle. When this option is not enabled, bandwidth usage of each month is still being tracked but no action will be taken.
Action	If Email Notification is enabled, you will receive an email notification when usage hits 75% and 95% of the monthly allowance. If the box Disconnect when usage hits 100% of monthly allowance is checked, this WAN connection will be disconnected automatically when the usage hits the monthly allowance. It will not resume unless this option has been turned off or the usage has been reset when a new billing cycle starts.
Start Day	This option allows you to select which day of the month a billing cycle starts.
Monthly Allowance	This field is to specify the bandwidth allowance for each billing cycle.

Additional Public IP Settings											
Additional Public IP Address	<table border="1"> <tr> <td>IP Address</td> <td><input type="text"/></td> </tr> <tr> <td>Subnet Mask</td> <td>255.255.255.0 (/24) ▼</td> </tr> <tr> <td colspan="2" style="text-align: center;">↓</td> </tr> <tr> <td colspan="2"> <div style="border: 1px solid gray; height: 40px; width: 100%;"></div> </td> </tr> <tr> <td colspan="2" style="text-align: right;">Delete</td> </tr> </table>	IP Address	<input type="text"/>	Subnet Mask	255.255.255.0 (/24) ▼	↓		<div style="border: 1px solid gray; height: 40px; width: 100%;"></div>		Delete	
IP Address	<input type="text"/>										
Subnet Mask	255.255.255.0 (/24) ▼										
↓											
<div style="border: 1px solid gray; height: 40px; width: 100%;"></div>											
Delete											

Additional Public IP Settings

If you have access to status public IP addresses,, you can assign them on this field.

Dynamic DNS Settings	
Dynamic DNS Service Provider	Disabled ▼

Dynamic DNS Settings

This setting specifies the dynamic DNS service provider to be used for the WAN based on supported dynamic DNS service providers:

Dynamic DNS Service Provider

- changeip.com
- dyndns.org
- no-ip.org
- tzo.com
- DNS-O-Matic

Select **Disabled** to disable this feature. See **Section 9.5** for configuration details.

10.1.1 DHCP Connection

There are four possible connection methods:

1. DHCP
2. Static IP
3. PPPoE
4. L2TP

The DHCP connection method is suitable if the ISP provides an IP address automatically using

DHCP (e.g., satellite modem, WiMAX modem, cable, Metro Ethernet, etc.).

Connection Method	<input type="text" value="DHCP"/>
Routing Mode	<input checked="" type="radio"/> NAT
IP Address	10.88.3.158
Subnet Mask	255.255.255.0
Default Gateway	10.88.3.253
Hostname (Optional)	<input type="text"/> <input type="checkbox"/> Use custom hostname
DNS Servers	<input checked="" type="checkbox"/> Obtain DNS server address automatically 10.88.3.1 <input type="checkbox"/> Use the following DNS server address(es) DNS Server 1: <input type="text"/> DNS Server 2: <input type="text"/>

DHCP Connection Settings

Routing Mode

NAT allows substituting the real address in a packet with a mapped address that is routable on the destination network. By clicking the help icon in this field, you can display the **IP Forwarding** option, if your network requires it.

IP Address/ Subnet Mask/ Default Gateway

This information is obtained from the ISP automatically.

Hostname (Optional)

If your service provider's DHCP server requires you to supply a hostname value upon acquiring an IP address, you may enter the value here. If your service provider does not provide you with the value, you can safely bypass this option.

DNS Servers

Each ISP may provide a set of DNS servers for DNS lookups. This setting specifies the DNS (Domain Name System) servers to be used when a DNS lookup is routed through this connection.

Selecting **Obtain DNS server address automatically** results in the DNS servers being assigned by the WAN DHCP server to be used for outbound DNS lookups over the connection. (The DNS servers are obtained along with the WAN IP address assigned from the DHCP server.)

When **Use the following DNS server address(es)** is selected, you may enter custom DNS server addresses for this WAN connection into the **DNS Server 1** and **DNS Server 2** fields.

10.1.2 Static IP Connection

The static IP connection method is suitable if your ISP provides a static IP address to connect directly.

Connection Method	Static IP ▾
Routing Mode	<input type="radio"/> NAT
IP Address	10.88.3.158
Subnet Mask	255.255.255.0
Default Gateway	10.88.3.253
IP Address	<input type="text"/>
Subnet Mask	255.255.255.0 (/24) ▾
Default Gateway	<input type="text"/>
DNS Servers	<input checked="" type="checkbox"/> Use the following DNS server address(es) DNS Server 1: <input type="text"/> DNS Server 2: <input type="text"/>

Static IP Settings

Routing Mode

NAT allows substituting the real address in a packet with a mapped address that is routable on the destination network. By clicking the help icon in this field, you can display the **IP Forwarding** option, if your network requires it.

IP Address / Subnet Mask / Default Gateway

These settings allow you to specify the information required in order to communicate on the Internet via a fixed Internet IP address. The information is typically determined by and can be obtained from the ISP.

DNS Servers

Each ISP may provide a set of DNS servers for DNS lookups. This setting specifies the DNS (Domain Name System) servers to be used when a DNS lookup is routed through this connection. Selecting **Obtain DNS server address automatically** results in the DNS servers being assigned by the WAN DHCP server to be used for outbound DNS lookups over the connection. (The DNS servers are obtained along with the WAN IP address assigned from the DHCP server.) When **Use the following DNS server address(es)** is selected, you may enter custom DNS server addresses for this WAN connection into the **DNS Server 1** and **DNS Server 2** fields.

10.1.3 PPPoE Connection

This connection method is suitable if your ISP provides a login ID/password to connect via PPPoE.

DNS Servers

Each ISP may provide a set of DNS servers for DNS lookups. This setting specifies the DNS (Domain Name System) servers to be used when a DNS lookup is routed through this connection.

Selecting **Obtain DNS server address automatically** results in the DNS servers assigned by the PPPoE server to be used for outbound DNS lookups over the WAN connection. (The DNS servers are obtained along with the WAN IP address assigned from the PPPoE server.)

When **Use the following DNS server address(es)** is selected, you can enter custom DNS server addresses for this WAN connection into the **DNS server 1** and **DNS server 2** fields.

10.2 Cellular WAN

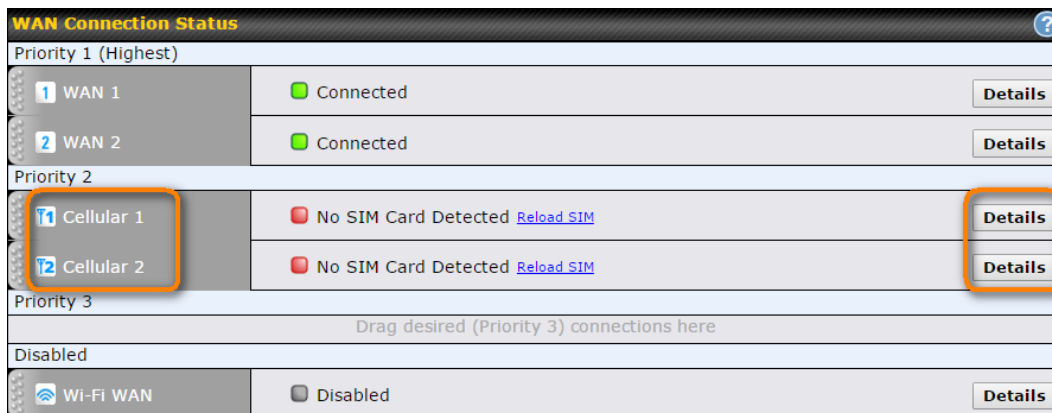

To access cellular WAN settings, click **Network>WAN>Details**.
(Available on the Pepwave MAX BR1, HD2, and HD2 IP67 only)



Cellular 1 Status	
IMSI	(No SIM Card Detected)
MEID	A100001F7DC038 270113180708241208
ESN	8052FC8A
IMEI	356144040031862

Cellular Status	
IMSI	This is the International Mobile Subscriber Identity which uniquely identifies the SIM card. This is applicable to 3G modems only.
MEID	Some Pepwave routers support both HSPA and EV-DO. For Sprint or Verizon Wireless EV-DO users, a unique MEID identifier code (in hexadecimal format) is used by the carrier to associate the EV-DO device with the user. This information is presented in hex and decimal format.
ESN	This serves the same purpose as MEID HEX but uses an older format.
IMEI	This is the unique ID for identifying the modem in GSM/HSPA mode.

WAN Connection Settings	
WAN Connection Name	Cellular 1 Default
Operating Schedule	Always on ▼
Subnet Selection ?	<input checked="" type="radio"/> Auto <input type="radio"/> Force /31 Subnet
Routing Mode ?	<input checked="" type="radio"/> NAT
DNS Servers	<input checked="" type="checkbox"/> Obtain DNS server address automatically <input type="checkbox"/> Use the following DNS server address(es) DNS Server 1: <input type="text"/> DNS Server 2: <input type="text"/>

WAN Connection Settings	
WAN Connection Name	Enter a name to represent this WAN connection.
Operating Schedule	Click the drop-down menu to apply a time schedule to this interface if needed.
Subnet Selection	Auto: The subnet mask will be set automatically. Force /31 Subnet: The subnet mask will be set as 255.255.255.254(/31), and the gateway IP address will be recalculated.
Routing Mode	This option allows you to select the routing method to be used in routing IP frames via the WAN connection. The mode can be either NAT (network address translation) or IP

Forwarding. Click the  button to enable IP forwarding.

Each ISP may provide a set of DNS servers for DNS lookups. This setting specifies the DNS (Domain Name System) servers to be used when a DNS lookup is routed through this connection.

DNS Servers

Selecting **Obtain DNS server address automatically** results in the DNS servers assigned by the PPPoE server to be used for outbound DNS lookups over the WAN connection. (The DNS servers are obtained along with the WAN IP address assigned from the PPPoE server.)

When **Use the following DNS server address(es)** is selected, you can enter custom DNS server addresses for this WAN connection into the **DNS server 1** and **DNS server 2** fields.

Cellular Settings ?	
SIM Card	<input checked="" type="radio"/> Both SIMs <input type="radio"/> SIM A Only <input type="radio"/> SIM B Only
Preferred SIM Card	<input checked="" type="radio"/> No Preference <input type="radio"/> SIM A <input type="radio"/> SIM B
3G/2G ?	Auto ▼
Authentication	Auto ▼
Band Selection	<input checked="" type="checkbox"/> WCDMA / HSDPA / HSUPA / HSPA+ (800 MHz) <input checked="" type="checkbox"/> WCDMA / HSDPA / HSUPA / HSPA+ (850 MHz) <input checked="" type="checkbox"/> WCDMA / HSDPA / HSUPA / HSPA+ (900 MHz) <input checked="" type="checkbox"/> WCDMA / HSDPA / HSUPA / HSPA+ (1700 MHz) <input checked="" type="checkbox"/> WCDMA / HSDPA / HSUPA / HSPA+ (1900 MHz) <input checked="" type="checkbox"/> WCDMA / HSDPA / HSUPA / HSPA+ (2100 MHz) <input checked="" type="checkbox"/> GSM / GPRS / EDGE (850 MHz) <input checked="" type="checkbox"/> GSM / GPRS / EDGE (900 MHz) <input checked="" type="checkbox"/> GSM / GPRS / EDGE (1800 MHz) <input checked="" type="checkbox"/> GSM / GPRS / EDGE (1900 MHz)
Data Roaming	<input type="checkbox"/>
Operator Settings	<input checked="" type="radio"/> Auto <input type="radio"/> Custom
APN	<input type="text"/>
Username	<input type="text"/>
Password	<input type="text"/>
Confirm Password	<input type="text"/>
SIM PIN (Optional) ?	<input type="text"/> <input type="text"/> (Confirm)
Bandwidth Allowance Monitor ?	<input checked="" type="checkbox"/> Enable
Action ?	<input type="checkbox"/> Disconnect when usage hits 100% Email notification is currently disabled. You can get notified when usage hits 75%/95% of monthly allowance by enabling Email Notification .
Start Day ?	On 1st ▼ of each month
Monthly Allowance ?	<input type="text"/> MB ▼

Cellular Settings	
SIM Card	Indicate which SIM card this cellular WAN will use. Only applies to cellular WAN with redundant SIM cards.
Preferred SIM	If both cards were enabled on the above field, then you can designate the priority of the SIM

Card	card slots here.
3G/2G	This drop-down menu allows restricting cellular to particular band. Click the  button to enable the selection of specific bands.
Authentication	Choose from PAP Only or CHAP Only to use those authentication methods exclusively. Select Auto to automatically choose an authentication method.
Data Roaming	This checkbox enables data roaming on this particular SIM card. Please check your service provider's data roaming policy before proceeding.
Operator Settings	This setting applies to 3G/EDGE/GPRS modems only. It does not apply to EVDO/EVDO Rev. A modems. This allows you to configure the APN settings of your connection. If Auto is selected, the mobile operator should be detected automatically. The connected device will be configured and connection will be made automatically. If there is any difficulty in making connection, you may select Custom to enter your carrier's APN, Login, Password, and Dial Number settings manually. The correct values can be obtained from your carrier. The default and recommended setting is Auto .
APN / Login / Password / SIM PIN	When Auto is selected, the information in these fields will be filled automatically. Select Custom to customize these parameters. The parameter values are determined by and can be obtained from the ISP.
Bandwidth Allowance Monitor	Check the box Enable to enable bandwidth usage monitoring on this WAN connection for each billing cycle. When this option is not enabled, bandwidth usage of each month is still being tracked but no action will be taken.
Action	If email notification is enabled, you will be notified by email when usage hits 75% and 95% of the monthly allowance. If Disconnect when usage hits 100% of monthly allowance is checked, this WAN connection will be disconnected automatically when the usage hits the monthly allowance. It will not resume connection unless this option has been turned off or the usage has been reset when a new billing cycle starts.
Start Day	This option allows you to define which day of the month each billing cycle begins.
Monthly Allowance	This field is for defining the maximum bandwidth usage allowed for the WAN connection each month.

General Settings	
Independent from Backup WANs ?	<input type="checkbox"/>
Standby State ?	<input checked="" type="radio"/> Remain connected <input type="radio"/> Disconnected
Idle Disconnect	<input type="checkbox"/>

General Settings	
Independent from Backup WANs	If this is checked, the connection will be working independent from other Backup WAN connections. Those in Backup Priority will ignore the status of this WAN connection, and will be used when none of the other higher priority connections are available.
Standby State	This option allows you to choose whether to remain connected or disconnected when this WAN connection is no longer in the highest priority and has entered the standby state. When Remain connected is chosen, bringing up this WAN connection to active makes it immediately available for use.
Idle Disconnect	When Internet traffic is not detected within the user-specified timeframe, the modem will automatically disconnect. Once the traffic is resumed by the LAN host, the connection will be re-activated.

Health Check Settings	
Health Check Method ?	SmartCheck ▾
Timeout ?	5 ▾ second(s)
Health Check Interval ?	10 ▾ second(s)
Health Check Retries ?	3 ▾
Recovery Retries ?	3 ▾

Health Check Settings	
Health Check Method	This setting allows you to specify the health check method for the cellular connection. Available options are Disabled , Ping , DNS Lookup , HTTP , and SmartCheck . The default method is DNS Lookup . See Section 10.4 for configuration details.
Timeout	If a health check test cannot be completed within the specified amount of time, the test will be treated as failed.
Health Check Interval	This is the time interval between each health check test.

Health Check Retries

This is the number of consecutive check failures before treating a connection as down.

Recovery Retries

This is the number of responses required after a health check failure before treating a connection as up again.

Dynamic DNS Settings	
Dynamic DNS Service Provider	Disabled

Dynamic DNS Settings

Dynamic DNS Service Provider

This setting specifies the dynamic DNS service provider to be used for the WAN based on supported dynamic DNS service providers:

- changeip.com
- dyndns.org
- no-ip.org
- tzo.com
- DNS-O-Matic

Select **Disabled** to disable this feature. See **Section 9.5** for configuration details.

MTU		1428	Default
-----	--	------	---------

MTU

MTU

This field is for specifying the Maximum Transmission Unit value of the WAN connection. An excessive MTU value can cause file downloads stall shortly after connected. You may consult your ISP for the connection's MTU value.

10.3 Wi-Fi WAN

To access Wi-Fi WAN settings, click **Network>WAN>Details**.

WAN Connection Settings	
WAN Connection Name	<input type="text" value="Wi-Fi WAN"/> <input type="button" value="Default"/>
Operating Schedule	<input type="text" value="Always on"/>
Independent from Backup WANs ?	<input type="checkbox"/>
Standby State	<input checked="" type="radio"/> Remain connected <input type="radio"/> Disconnected
MTU ?	<input type="radio"/> Auto <input checked="" type="radio"/> Custom Value: <input type="text" value="1500"/> <input type="button" value="Default"/>
Reply to ICMP PING ?	<input checked="" type="radio"/> Yes <input type="radio"/> No

WAN Connection Settings	
WAN Connection Name	Enter a name to represent this WAN connection.
Operating Schedule	Click the drop-down menu to apply a time schedule to this interface.
Independent from Backup WANs	If this is checked, the connection will be working independent from other Backup WAN connections. Those in Backup Priority will ignore the status of this WAN connection, and will be used when none of the other higher priority connections are available.
Standby State	This setting specifies the state of the WAN connection while in standby. The available options are Remain Connected (hot standby) and Disconnect (cold standby).
MTU	This setting specifies the maximum transmission unit. By default, MTU is set to Custom 1440 . You may adjust the MTU value by editing the text field. Click Default to restore the default MTU value. Select Auto and the appropriate MTU value will be automatically detected. The auto-detection will run each time the WAN connection establishes
Reply to ICMP PING	If this setting is disabled, the WAN connection will not respond to ICMP ping requests. By default, this setting is enabled.

Wi-Fi WAN Settings ?	
Channel Width	20 MHz
Channel Selection	<input checked="" type="radio"/> Auto <input type="radio"/> Custom
Data Rate	<input checked="" type="radio"/> Auto <input type="radio"/> Fixed
Output Power	Max <input type="checkbox"/> Boost
Roaming	<input type="checkbox"/>
Connect to Any Open Mode AP ?	<input type="radio"/> Yes <input checked="" type="radio"/> No
Beacon Miss Counter	5

Wi-Fi WAN Settings	
Channel Width	Select the channel width for this Wi-Fi WAN. 20MHz will have greater support for older devices using 2.4Ghz, while 40MHz is appropriate for networks with newer devices that connect using 5Ghz
Channel Selection	Determine whether the channel will be automatically selected. If you select custom, the following table will appear: <div style="border: 1px solid gray; padding: 5px; margin: 10px 0;"> </div>
Data Rate	Selecting Auto will enable the router to automatically determine the best data rate, while manually selecting a rate will force devices to connect using the fixed rate.
Output Power	If you are setting up a network with many Wi-Fi devices in close proximity, then you can configure the output power here. Click the “boost” button for additional power. However, with that option ticked, output power may exceed local regulatory limits.
Roaming	Checking this box will enable Wi-Fi roaming. Click the ? icon for additional options.
Connect to Any Open Mode AP	This option is to specify whether the Wi-Fi WAN will connect to any open mode access points it finds.
Beacon Miss	This sets the threshold for the number of missed beacons.

Counter

Bandwidth Allowance Monitor	
Bandwidth Allowance Monitor	<input checked="" type="checkbox"/> Enable
Action	Email notification is currently disabled. You can get notified when usage hits 75%/95% of monthly allowance by enabling Email Notification . <input checked="" type="checkbox"/> Disconnect when usage hits 100% of monthly allowance
Start Day	On <input type="text" value="1st"/> of each month at 00:00 midnight
Monthly Allowance	<input type="text"/> MB

Bandwidth Allowance Monitor

Action

If **Error! Reference source not found.** is enabled, you will be notified by email when usage hits 75% and 95% of the monthly allowance.

If **Disconnect when usage hits 100% of monthly allowance** is checked, this WAN connection will be disconnected automatically when the usage hits the monthly allowance. It will not resume connection unless this option has been turned off or the usage has been reset when a new billing cycle starts.

Start Day

This option allows you to define which day of the month each billing cycle begins.

Monthly Allowance

This field is for defining the maximum bandwidth usage allowed for the WAN connection each month.

Health Check Settings	
Health Check Method	<input type="text" value="DNS Lookup"/>
Health Check DNS Servers	Host 1: <input type="text"/> Host 2: <input type="text"/> <input checked="" type="checkbox"/> Use first two DNS servers as Health Check DNS Servers <input type="checkbox"/> Include public DNS servers
Timeout	<input type="text" value="5"/> second(s)
Health Check Interval	<input type="text" value="5"/> second(s)
Health Check Retries	<input type="text" value="3"/>
Recovery Retries	<input type="text" value="3"/>

Health Check Settings

Method

This setting specifies the health check method for the WAN connection. This value can be configured as **Disabled**, **PING**, **DNS Lookup**, or **HTTP**. The default method is **DNS Lookup**. For mobile Internet connections, the value of **Method** can be configured as **Disabled** or **SmartCheck**.

Health Check Disabled

Health Check Settings	
Health Check Method	<input type="text" value="Disabled"/> <small>Health Check disabled. Network problem cannot be detected.</small>

When **Disabled** is chosen in the **Method** field, the WAN connection will always be considered as up. The connection will **NOT** be treated as down in the event of IP routing errors.

Health Check Method: PING

Health Check Method	<input type="text" value="PING"/>
PING Hosts	<input type="text" value="Host 1:"/> <input type="text" value="Host 2:"/> <input checked="" type="checkbox"/> Use first two DNS servers as PING Hosts

ICMP ping packets will be issued to test the connectivity with a configurable target IP address or hostname. A WAN connection is considered as up if ping responses are received from either one or both of the ping hosts.

PING Hosts

This setting specifies IP addresses or hostnames with which connectivity is to be tested via ICMP ping. If **Use first two DNS servers as Ping Hosts** is checked, the target ping host will be the first DNS server for the corresponding WAN connection. Reliable ping hosts with a high uptime should be considered. By default, the first two DNS servers of the WAN connection are used as the ping hosts.

Health Check Method: DNS Lookup

Health Check Method	<input type="text" value="DNS Lookup"/>
Health Check DNS Servers	<input type="text" value="Host 1:"/> <input type="text" value="Host 2:"/> <input checked="" type="checkbox"/> Use first two DNS servers as Health Check DNS Servers <input type="checkbox"/> Include public DNS servers

DNS lookups will be issued to test connectivity with target DNS servers. The connection will be treated as up if DNS responses are received from one or both of the servers, regardless of whether the result was positive or negative.

Health Check DNS Servers

This field allows you to specify two DNS hosts' IP addresses with which connectivity is to be tested via DNS Lookup.

If **Use first two DNS servers as Health Check DNS Servers** is checked, the first two DNS servers will be the DNS lookup targets for checking a connection's health. If the box is not checked, **Host 1** must be filled, while a value for **Host 2** is optional.

If **Include public DNS servers** is selected and no response is received from all specified DNS servers, DNS lookups will also be issued to some public DNS servers. A WAN connection will be treated as down only if there is also no response received from the public DNS servers.

Connections will be considered as up if DNS responses are received from any one of the health check DNS servers, regardless of a positive or negative result. By default, the first two DNS servers of the WAN connection are used as the health check DNS servers.

Health Check Method: HTTP

Health Check Method	HTTP
URL 1	http:// <input type="text"/> Matching String: <input type="checkbox"/>
URL 2	http:// <input type="text"/> Matching String: <input type="checkbox"/>

HTTP connections will be issued to test connectivity with configurable URLs and strings to match.

URL1

WAN Settings>WAN Edit>Health Check Settings>URL1

The URL will be retrieved when performing an HTTP health check. When **String to Match** is left blank, a health check will pass if the HTTP return code is between 200 and 299 (Note: HTTP redirection codes 301 or 302 are treated as failures). When **String to Match** is filled, a health check will pass if the HTTP return code is between 200 and 299 and if the HTTP response content contains the string.

URL 2

WAN Settings>WAN Edit>Health Check Settings>URL2

If **URL2** is also provided, a health check will pass if either one of the tests passed.

Other Health Check Settings

Timeout	5 second(s)
Health Check Interval	5 second(s)
Health Check Retries	3
Recovery Retries	3

Timeout

This setting specifies the timeout in seconds for ping/DNS lookup requests. The default timeout is **5 seconds**.

Health Check Interval

This setting specifies the time interval in seconds between ping or DNS lookup requests. The default health check interval is **5 seconds**.

Health Check Retries

This setting specifies the number of consecutive ping/DNS lookup timeouts after which the Peplink Balance will treat the corresponding WAN connection as down. Default health retries is set to **3**. Using the default **Health Retries** setting of **3**, the corresponding WAN

connection will be treated as down after three consecutive timeouts.

Recovery Retries

This setting specifies the number of consecutive successful ping/DNS lookup responses that must be received before the Peplink Balance treats a previously down WAN connection as up again. By default, **Recover Retries** is set to **3**. Using the default setting, a WAN connection that is treated as down will be considered as up again upon receiving three consecutive successful ping/DNS lookup responses.

Dynamic DNS Settings	
Service Provider	DNS-O-Matic
Username	
Password	
Confirm Password	
Update All Hosts	<input type="checkbox"/>
Hosts / IDs	

Dynamic DNS Settings

Service Provider

This setting specifies the dynamic DNS service provider to be used for the WAN. Supported providers are:

- changeip.com
- dyndns.org
- no-ip.org
- tzo.com
- DNS-O-Matic

Select **Disabled** to disable this feature.

User ID / User / Email

This setting specifies the registered user name for the dynamic DNS service.

Password / Pass / TZO Key

This setting specifies the password for the dynamic DNS service.

Update All Hosts

Check this box to automatically update all hosts.

This setting specifies a list of hostnames or domains to be associated with the public Internet IP address of the WAN connection.

Hosts / Domain

Important Note

In order to use dynamic DNS services, appropriate hostname registration(s), as well as a valid account with a supported dynamic DNS service provider, are required.
 A dynamic DNS update is performed whenever a WAN's IP address is changed, such as when an IP is changed after a DHCP IP refresh or reconnection.
 Due to dynamic DNS service providers' policies, a dynamic DNS host expires automatically when the host record has not been updated for a long time. Therefore, the Peplink Balance performs an update every 23 days, even if a WAN's IP address did not change.

10.3.1 Creating Wi-Fi Connection Profiles

You can manually create a profile to connect to a Wi-Fi connection. This is useful for creating a profile for connecting to hidden-SSID access points. Click **Network>WAN>Details>Create Profile...** to get started.

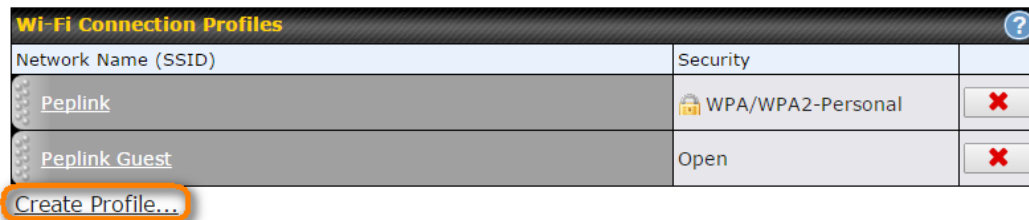

This will open a window similar to the one shown below

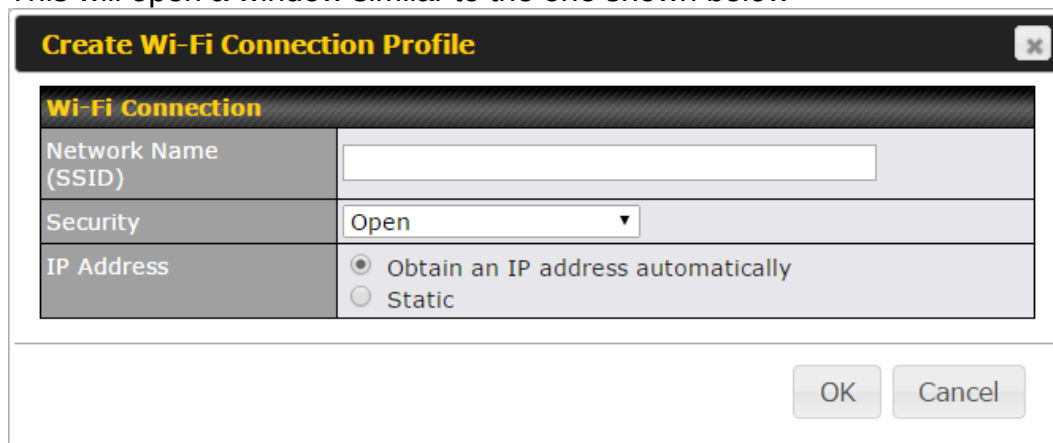

Wi-Fi Connection Profile Settings

Type	Select whether the network will connect automatically or manually.													
Network Name (SSID)	Enter a name to represent this Wi-Fi connection.													
Security	This option allows you to select which security policy is used for this wireless network. Available options:													
	<ul style="list-style-type: none"> Open <table border="1" style="width: 100%; border-collapse: collapse;"> <tr> <td style="width: 30%;">Security</td> <td>Open</td> </tr> </table> 	Security	Open											
	Security	Open												
	<ul style="list-style-type: none"> WEP <table border="1" style="width: 100%; border-collapse: collapse;"> <tr> <td style="width: 30%;">Security</td> <td>WEP</td> </tr> <tr> <td>Encryption Key</td> <td><input type="text"/></td> </tr> <tr> <td></td> <td><input checked="" type="checkbox"/> Hide Characters</td> </tr> </table> 	Security	WEP	Encryption Key	<input type="text"/>		<input checked="" type="checkbox"/> Hide Characters							
	Security	WEP												
Encryption Key	<input type="text"/>													
	<input checked="" type="checkbox"/> Hide Characters													
<ul style="list-style-type: none"> WPA/WPA2 – Personal <table border="1" style="width: 100%; border-collapse: collapse;"> <tr> <td style="width: 30%;">Security</td> <td>WPA/WPA2-Personal</td> </tr> <tr> <td>Shared Key</td> <td><input type="text"/></td> </tr> <tr> <td></td> <td><input checked="" type="checkbox"/> Hide Characters</td> </tr> </table> 	Security	WPA/WPA2-Personal	Shared Key	<input type="text"/>		<input checked="" type="checkbox"/> Hide Characters								
Security	WPA/WPA2-Personal													
Shared Key	<input type="text"/>													
	<input checked="" type="checkbox"/> Hide Characters													
<ul style="list-style-type: none"> WPA/WPA2 – Enterprise <table border="1" style="width: 100%; border-collapse: collapse;"> <tr> <td style="width: 30%;">Security</td> <td>WPA/WPA2-Enterprise</td> </tr> <tr> <td>Login ID</td> <td><input type="text"/></td> </tr> <tr> <td>Password</td> <td><input type="text"/></td> </tr> <tr> <td>Confirm Password</td> <td><input type="text"/></td> </tr> <tr> <td>EAP Method</td> <td>PEAP</td> </tr> <tr> <td>EAP Phase 2 Method</td> <td>EAP/CHAP</td> </tr> <tr> <td>EAP outer authentication identity</td> <td> <input checked="" type="radio"/> Anonymous <input type="radio"/> User Credentials <input type="radio"/> Other: <input type="text"/> </td> </tr> </table> 	Security	WPA/WPA2-Enterprise	Login ID	<input type="text"/>	Password	<input type="text"/>	Confirm Password	<input type="text"/>	EAP Method	PEAP	EAP Phase 2 Method	EAP/CHAP	EAP outer authentication identity	<input checked="" type="radio"/> Anonymous <input type="radio"/> User Credentials <input type="radio"/> Other: <input type="text"/>
Security	WPA/WPA2-Enterprise													
Login ID	<input type="text"/>													
Password	<input type="text"/>													
Confirm Password	<input type="text"/>													
EAP Method	PEAP													
EAP Phase 2 Method	EAP/CHAP													
EAP outer authentication identity	<input checked="" type="radio"/> Anonymous <input type="radio"/> User Credentials <input type="radio"/> Other: <input type="text"/>													

10.4 WAN Health Check

To ensure traffic is routed to healthy WAN connections only, the Pepwave router can periodically check the health of each WAN connection. The health check settings for each WAN connection can be independently configured via **Network>WAN>Details**.

Health Check Settings

Method	This setting specifies the health check method for the WAN connection. This value can be configured as Disabled , PING , DNS Lookup , or HTTP . The default method is DNS Lookup . For mobile Internet connections, the value of Method can be configured as Disabled or SmartCheck .
---------------	---

Health Check Disabled

Health Check Method	<input style="float: left; margin-right: 5px;" type="button" value="?"/> Disabled ▼ <small>Health Check disabled. Network problem cannot be detected.</small>
---------------------	---

When **Disabled** is chosen in the **Method** field, the WAN connection will always be considered as up. The connection will **NOT** be treated as down in the event of IP routing errors.

Health Check Method: PING

Health Check Method	<input style="float: left; margin-right: 5px;" type="button" value="?"/> PING ▼
PING Hosts	<input style="float: left; margin-right: 5px;" type="button" value="?"/> Host 1: <input style="width: 150px;" type="text"/> Host 2: <input style="width: 150px;" type="text"/> <input checked="" type="checkbox"/> Use first two DNS servers as PING Hosts

ICMP ping packets will be issued to test the connectivity with a configurable target IP address or hostname. A WAN connection is considered as up if ping responses are received from either one or both of the ping hosts.

PING Hosts

This setting specifies IP addresses or hostnames with which connectivity is to be tested via ICMP ping. If **Use first two DNS servers as Ping Hosts** is checked, the target ping host will be the first DNS server for the corresponding WAN connection. Reliable ping hosts with a high uptime should be considered. By default, the first two DNS servers of the WAN connection are used as the ping hosts.

Health Check Method: DNS Lookup

Health Check Method	<input style="float: left; margin-right: 5px;" type="button" value="?"/> DNS Lookup ▼
Health Check DNS Servers	<input style="float: left; margin-right: 5px;" type="button" value="?"/> Host 1: <input style="width: 150px;" type="text"/> Host 2: <input style="width: 150px;" type="text"/> <input checked="" type="checkbox"/> Use first two DNS servers as Health Check DNS Servers <input type="checkbox"/> Include public DNS servers

DNS lookups will be issued to test connectivity with target DNS servers. The connection will be treated as up if DNS responses are received from one or both of the servers, regardless of whether the result was positive or negative.

Health Check DNS Servers

This field allows you to specify two DNS hosts' IP addresses with which connectivity is to be tested via DNS lookup.
 If **Use first two DNS servers as Health Check DNS Servers** is checked, the first two DNS servers will be the DNS lookup targets for checking a connection's health. If the box is not checked, **Host 1** must be filled, while a value for **Host 2** is optional.
 If **Include public DNS servers** is selected and no response is received from all specified DNS servers, DNS lookups will also be issued to some public DNS servers. A WAN connection will be treated as down only if there is also no response received from the public DNS servers.
 Connections will be considered as up if DNS responses are received from any one of the health check DNS servers, regardless of a positive or negative result. By default, the first two DNS servers of the WAN connection are used as the health check DNS servers.

Health Check Method: HTTP

HTTP connections will be issued to test connectivity with configurable URLs and strings to match.

Health Check Method	<input style="float: left; margin-right: 5px;" type="button" value="?"/> HTTP ▼
URL 1	<input style="float: left; margin-right: 5px;" type="button" value="?"/> http:// <input style="width: 150px;" type="text"/> Matching String: <input type="checkbox"/>
URL 2	<input style="float: left; margin-right: 5px;" type="button" value="?"/> http:// <input style="width: 150px;" type="text"/> Matching String: <input type="checkbox"/>

http://www

URL1	<p>WAN Settings>WAN Edit>Health Check Settings>URL1 The URL will be retrieved when performing an HTTP health check. When String to Match is left blank, a health check will pass if the HTTP return code is between 200 and 299 (Note: HTTP redirection codes 301 or 302 are treated as failures). When String to Match is filled, a health check will pass if the HTTP return code is between 200 and 299 and if the HTTP response content contains the string.</p>
URL 2	<p>WAN Settings>WAN Edit>Health Check Settings>URL2 If URL2 is also provided, a health check will pass if either one of the tests passed.</p>

Timeout	10 ▾ second(s)
Health Check Interval	5 ▾ second(s)
Health Check Retries	3 ▾
Recovery Retries	3 ▾

Other Health Check Settings	
Timeout	This setting specifies the timeout in seconds for ping/DNS lookup requests. The default timeout is 5 seconds .
Health Check Interval	This setting specifies the time interval in seconds between ping or DNS lookup requests. The default health check interval is 5 seconds .
Health Check Retries	This setting specifies the number of consecutive ping/DNS lookup timeouts after which the Pepwave router will treat the corresponding WAN connection as down. Default health retries is set to 3 . Using the default Health Retries setting of 3 , the corresponding WAN connection will be treated as down after three consecutive timeouts.
Recovery Retries	This setting specifies the number of consecutive successful ping/DNS lookup responses that must be received before the Pepwave router treats a previously down WAN connection as up again. By default, Recover Retries is set to 3 . Using the default setting, a WAN connection that is treated as down will be considered as up again upon receiving three consecutive successful ping/DNS lookup responses.

Automatic Public DNS Server Check on DNS Test Failure

When the health check method is set to **DNS Lookup** and health checks fail, the Pepwave router will automatically perform DNS lookups on public DNS servers. If the tests are successful, the WAN may not be down, but rather the target DNS server malfunctioned. You will see the following warning message on the main page:

Failed to receive DNS response from the health-check DNS servers for WAN connection 3. But public DNS server lookup test via the WAN passed. So please check the DNS server settings.

10.5 Dynamic DNS Settings

Pepwave routers are capable of registering the domain name relationships to dynamic DNS service providers. Through registration with dynamic DNS service provider(s), the default public Internet IP address of each WAN connection can be associated with a host name. With dynamic DNS service enabled for a WAN connection, you can connect to your WAN's IP address from the external, even if its IP address is dynamic. You must register for an account from the listed dynamic DNS service providers before enabling this option.

If the WAN connection's IP address is a reserved private IP address (i.e., behind a NAT router), the public IP of each WAN will be automatically reported to the DNS service provider.

Either upon a change in IP addresses or every 23 days without link reconnection, the Pepwave router will connect to the dynamic DNS service provider to perform an IP address update within the provider's records.

The settings for dynamic DNS service provider(s) and the association of hostname(s) are configured via **Network>WAN>Details>Dynamic DNS Service Provider/Dynamic DNS Settings**.

Dynamic DNS Service Provider	<input type="text" value="changeip.com"/>
User ID	<input type="text"/>
Password	<input type="text"/>
Confirm Password	<input type="text"/>
Hosts	<input type="text"/>

Dynamic DNS Settings

This setting specifies the dynamic DNS service provider to be used for the WAN based on supported dynamic DNS service providers:

Dynamic DNS

- changeip.com
- dyndns.org
- no-ip.org
- tzo.com
- DNS-O-Matic
- Others...

Support custom Dynamic DNS servers by entering its URL. Works with

	any service compatible with DynDNS API. Select Disabled to disable this feature.
Account Name / Email Address	This setting specifies the registered user name for the dynamic DNS service.
Password / TZO Key	This setting specifies the password for the dynamic DNS service.
Hosts / Domain	This field allows you to specify a list of host names or domains to be associated with the public Internet IP address of the WAN connection. If you need to enter more than one host, use a carriage return to separate them.

Important Note

In order to use dynamic DNS services, appropriate host name registration(s) and a valid account with a supported dynamic DNS service provider are required. A dynamic DNS update is performed whenever a WAN's IP address changes (e.g., the IP is changed after a DHCP IP refresh, reconnection, etc.). Due to dynamic DNS service providers' policy, a dynamic DNS host will automatically expire if the host record has not been updated for a long time. Therefore the Pepwave router performs an update every 23 days, even if a WAN's IP address has not changed.

11 Advanced Wi-Fi Settings

Wi-Fi settings can be configured at **Advanced>Wi-Fi Settings** (or **AP>Settings** on some models). Note that menus displayed can vary by model.

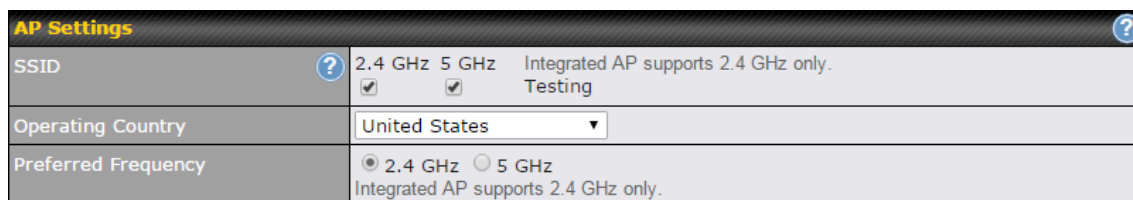

AP Settings	
SSID	You can select the wireless networks for 2.4 GHz or 5 GHz separately for each SSID.
Operating Country	<p>This drop-down menu specifies the national/regional regulations which the Wi-Fi radio should follow.</p> <ul style="list-style-type: none"> • If a North American region is selected, RF channels 1 to 11 will be available and the maximum transmission power will be 26 dBm (400 mW). • If European region is selected, RF channels 1 to 13 will be available. The

maximum transmission power will be 20 dBm (100 mW).
 NOTE: Users are required to choose an option suitable to local laws and regulations.

Preferred Frequency

Indicate the preferred frequency to use for clients to connect.

Important Note

Per FCC regulation, the country selection is not available on all models marketed in the US. All US models are fixed to US channels only.

	2.4 GHz	5 GHz
Protocol	802.11ng	802.11n/ac
Channel Width	20 MHz	Auto
Channel	Auto <input type="button" value="Edit"/> Channels: 1 2 3 4 5 6 7 8 9 10 11	Auto <input type="button" value="Edit"/> Channels: 36 40 44 48 52 56 60 64 100 104 108 112 116 120 124 128 132 136 140 149 153 157 161 165
Auto Channel Update	Daily at 03:00 <input checked="" type="checkbox"/> Wait until no active client associated	Daily at 03:00 <input checked="" type="checkbox"/> Wait until no active client associated
Output Power	Fixed: Max <input type="checkbox"/> Boost	Fixed: Max <input type="checkbox"/> Boost
Client Signal Strength Threshold	0 -95 dBm (0: Unlimited)	0 -95 dBm (0: Unlimited)
Maximum number of clients	0 (0: Unlimited)	0 (0: Unlimited)

AP Settings (part 2)

Protocol

This option allows you to specify whether 802.11b and/or 802.11g client association requests will be accepted. Available options are **802.11ng** and **802.11na**. By default, **802.11ng** is selected.

Channel Width

Available options are **20 MHz**, **40 MHz**, and **Auto (20/40 MHz)**. Default is **Auto (20/40 MHz)**, which allows both widths to be used simultaneously.

Channel

This option allows you to select which 802.11 RF channel will be utilized. **Channel 1 (2.412 GHz)** is selected by default.

Auto Channel Update

Indicate the time of day at which update automatic channel selection.

Output Power

This option is for specifying the transmission output power for the Wi-Fi AP. There are 4 relative power levels available – **Max**, **High**, **Mid**, and **Low**. The actual output power will be bound by the regulatory limits of the selected country.

Client Signal Strength Threshold

This setting determines the maximum strength at which the Wi-Fi AP can broadcast

Maximum number of clients

This setting determines the maximum number of clients that can connect to this Wi-Fi frequency.

Advanced Wi-Fi AP settings can be displayed by clicking the on the top right-hand corner of the **Wi-Fi AP Settings** section, which can be found at **AP>Settings**. Other models will display a separate section called **Wi-Fi AP Advanced Settings**, which can be found at **Advanced>Wi-Fi Settings**.

Management VLAN ID		Untagged LAN (No VLAN) ▾
Operating Schedule		Always on ▾
Beacon Rate		1 Mbps ▾ 6 Mbps will be used for 5 GHz radio
Beacon Interval		100 ms ▾
DTIM		1 <input type="text"/> Default
RTS Threshold		0 <input type="text"/> Default
Fragmentation Threshold		0 <input type="text"/> (0: Disable) Default
Distance / Time Converter		 4050 <input type="text"/> m Note: Input distance for recommended values
Slot Time		<input type="radio"/> Auto <input checked="" type="radio"/> Custom 9 <input type="text"/> μ s Default
ACK Timeout		48 <input type="text"/> μ s Default
Frame Aggregation		<input type="checkbox"/>

Advanced AP Settings

Management VLAN ID

This field specifies the VLAN ID to tag to management traffic, such as communication traffic between the AP and the AP Controller. The value is zero by default, which means that no VLAN tagging will be applied.

NOTE: Change this value with caution as alterations may result in loss of connection to the AP Controller.

Operating Schedule

Choose from the schedules that you have defined in System>Schedule. Select the schedule for the integrated AP to follow from the drop-down menu.

Beacon Rate ^A

This option is for setting the transmit bit rate for sending a beacon. By default, **1Mbps** is

	selected.
Beacon Interval ^A	This option is for setting the time interval between each beacon. By default, 100ms is selected.
DTIM ^A	This field allows you to set the frequency for the beacon to include delivery traffic indication messages. The interval is measured in milliseconds. The default value is set to 1 ms .
RTS Threshold ^A	The RTS (Request to Clear) threshold determines the level of connection required before the AP starts sending data. The recommended standard of the RTS threshold is around 500.
Fragmentation Threshold ^A	This setting determines the maximum size of a packet before it gets fragmented into multiple pieces.
Distance / Time Convertor	Select the range you wish to cover with your Wi-Fi, and the router will make recommendations for the Slot Time and ACK Timeout.
Slot Time ^A	This field is for specifying the unit wait time before transmitting a packet. By default, this field is set to 9 μs .
ACK Timeout ^A	This field is for setting the wait time to receive an acknowledgement packet before performing a retransmission. By default, this field is set to 48 μs .
Frame Aggregation ^A	This option allows you to enable frame aggregation to increase transmission throughput.

^A - Advanced feature, please click the  button on the top right-hand corner to activate.

Web Administration Settings (on External AP)	
Enable	<input checked="" type="checkbox"/>
Web Access Protocol	<input type="radio"/> HTTP <input checked="" type="radio"/> HTTPS
Management Port	443
HTTP to HTTPS Redirection	<input checked="" type="checkbox"/>
Admin Username	admin
Admin Password	601202b1afc6 <input type="button" value="Generate"/>

Web Administration Settings	
Enable	Ticking this box enables web admin access for APs located on the WAN.
Web Access Protocol	Determines whether the web admin portal can be accessed through HTTP or HTTPS
Management Port	Determines the port at which the management UI can be accessed.
Admin Username	Determines the username to be used for logging into the web admin portal
Admin Password	Determines the password for the web admin portal on external AP.

Wi-Fi WAN settings can be configured at **Advanced>Wi-Fi Settings** (or **Advanced>Wi-Fi WAN** or some models).

Wi-Fi WAN Settings	
Channel Width	20/40 MHz
Bit Rate	Auto
Output Power	Max <input type="checkbox"/> Boost

Wi-Fi WAN Settings	
Channel Width	Available options are 20/40 MHz and 20 MHz . Default is 20/40 MHz , which allows both widths to be used simultaneously.
Bit Rate	This option allows you to select a specific bit rate for data transfer over the device's Wi-

Fi network. By default, **Auto** is selected.

Output Power

This option is for specifying the transmission output power for the Wi-Fi AP. There are 4 relative power levels available – **Max**, **High**, **Mid**, and **Low**. The actual output power will be bound by the regulatory limits of the selected country. Note that selecting the **Boost** option may cause the MAX's radio output to exceed local regulatory limits.

12 MediaFast Configuration

MediaFast settings can be configured from the **Network** menu.

12.1 Setting Up MediaFast Content Caching

To access MediaFast content caching settings, select **Advanced>Cache Control**

Cache Control															
Domains / IP Addresses	<input type="radio"/> Cache all <input checked="" type="radio"/> Whitelist <input type="radio"/> Blacklist <div style="border: 1px solid #ccc; padding: 5px; min-height: 40px;">ted.com</div>														
Source IP Subnet	<input type="radio"/> Any <input checked="" type="radio"/> Custom	<table border="1"> <thead> <tr> <th>Network</th> <th>Subnet Mask</th> <th></th> </tr> </thead> <tbody> <tr> <td>10.8.41.0</td> <td>255.255.255.0 (/24)</td> <td style="text-align: center;">✘</td> </tr> <tr> <td>10.8.76.0</td> <td>255.255.255.0 (/24)</td> <td style="text-align: center;">✘</td> </tr> <tr> <td></td> <td>255.255.255.0 (/24)</td> <td style="text-align: center;">+</td> </tr> </tbody> </table>		Network	Subnet Mask		10.8.41.0	255.255.255.0 (/24)	✘	10.8.76.0	255.255.255.0 (/24)	✘		255.255.255.0 (/24)	+
Network	Subnet Mask														
10.8.41.0	255.255.255.0 (/24)	✘													
10.8.76.0	255.255.255.0 (/24)	✘													
	255.255.255.0 (/24)	+													
Content Type	<input checked="" type="checkbox"/> Video <input checked="" type="checkbox"/> Audio <input checked="" type="checkbox"/> Images <input checked="" type="checkbox"/> OS / Application Updates														
Cache Lifetime Settings	<table border="1"> <thead> <tr> <th>File Extension</th> <th>Lifetime (days)</th> <th></th> </tr> </thead> <tbody> <tr> <td>jpg</td> <td>30</td> <td style="text-align: center;">✘</td> </tr> <tr> <td></td> <td></td> <td style="text-align: center;">+</td> </tr> </tbody> </table>			File Extension	Lifetime (days)		jpg	30	✘			+			
File Extension	Lifetime (days)														
jpg	30	✘													
		+													

Cache Control Settings

Domain Choose to **Cache on all domains**, or enter domain names and then choose either **Cache the specified domains only** or **Do not cache the specified domains**.

Source IP This setting allows caching to be applied to the user-specified IP subnets. If "Any" is

Subnet	selected, then caching will apply to all subnets.
Content Type	Check these boxes to cache the listed content types or leave boxes unchecked to disable caching for the listed types.
Cache Lifetime Settings	Enter a file extension, such as JPG or DOC. Then enter a lifetime in days to specify how long files with that extension will be cached. Add or delete entries using the controls on the right.

12.2 Scheduling Content Prefetching

Content prefetching allows you to download content on a schedule that you define, which can help to preserve network bandwidth during busy times and keep costs down. To access MediaFast content prefetching settings, select **Advanced >Prefetch Schedule**.

Prefetch Schedule





Name	Status	Next Run Time	Last Run Time	Last Duration	Result	Last Download	Actions
▶ Course Progress	Downloading	04-11 06:00	04-09 02:03	-		0 B	
▶ National Geog	Ready	04-11 00:00	04-09 00:00	00:01		4.98 kB	
▶ Syllabus	Downloading	04-11 06:00	04-09 06:00	-		0 B	
▶ Vimeo	Ready	04-11 00:00	04-09 02:03	00:01		115.91 kB	
▶ ted	Ready	04-11 00:00	04-09 00:00	00:01		62.26 kB	

[New Schedule](#)

Tools

[Clear Web Cache](#) [Clear Statistics](#)

Prefetch Schedule Settings	
Name	This field displays the name given to the scheduled download.
Status	Check the status of your scheduled download here.
Next Run Time/Last Run Time	These fields display the date and time of the next and most recent occurrences of the scheduled download.
Last Duration	Check this field to ensure that the most recent download took as long as expected to complete. A value that is too low might indicate an incomplete download or incorrectly specified download target, while a value that is too long could mean a download with an incorrectly specified target or stop time.

Result	This field indicates whether downloads are in progress (🔄) or complete (✅).
Last Download	Check this field to ensure that the most recent download file size is within the expected range. A value that is too low might indicate an incomplete download or incorrectly specified download target, while a value that is too long could mean a download with an incorrectly specified target or stop time. This field is also useful for quickly seeing which downloads are consuming the most storage space.
Actions	<p>To begin a scheduled download immediately, click .</p> <p>To cancel a scheduled download, click .</p> <p>To edit a scheduled download, click .</p> <p>To delete a scheduled download, click .</p>
New Schedule	<p>Click to begin creating a new scheduled download. Clicking the button will cause the following screen to appear:</p> <div data-bbox="386 777 1031 1123" data-label="Form"> </div> <p>Simply provide the requested information to create your schedule.</p>
Clear Web Cache	To clear all cached content, click this button. Note that this action cannot be undone.
Clear Statistics	To clear all prefetch and status page statistics, click this button.

12.3 Viewing MediaFast Statistics

To get details on storage and bandwidth usage, select **Status>MediaFast**.

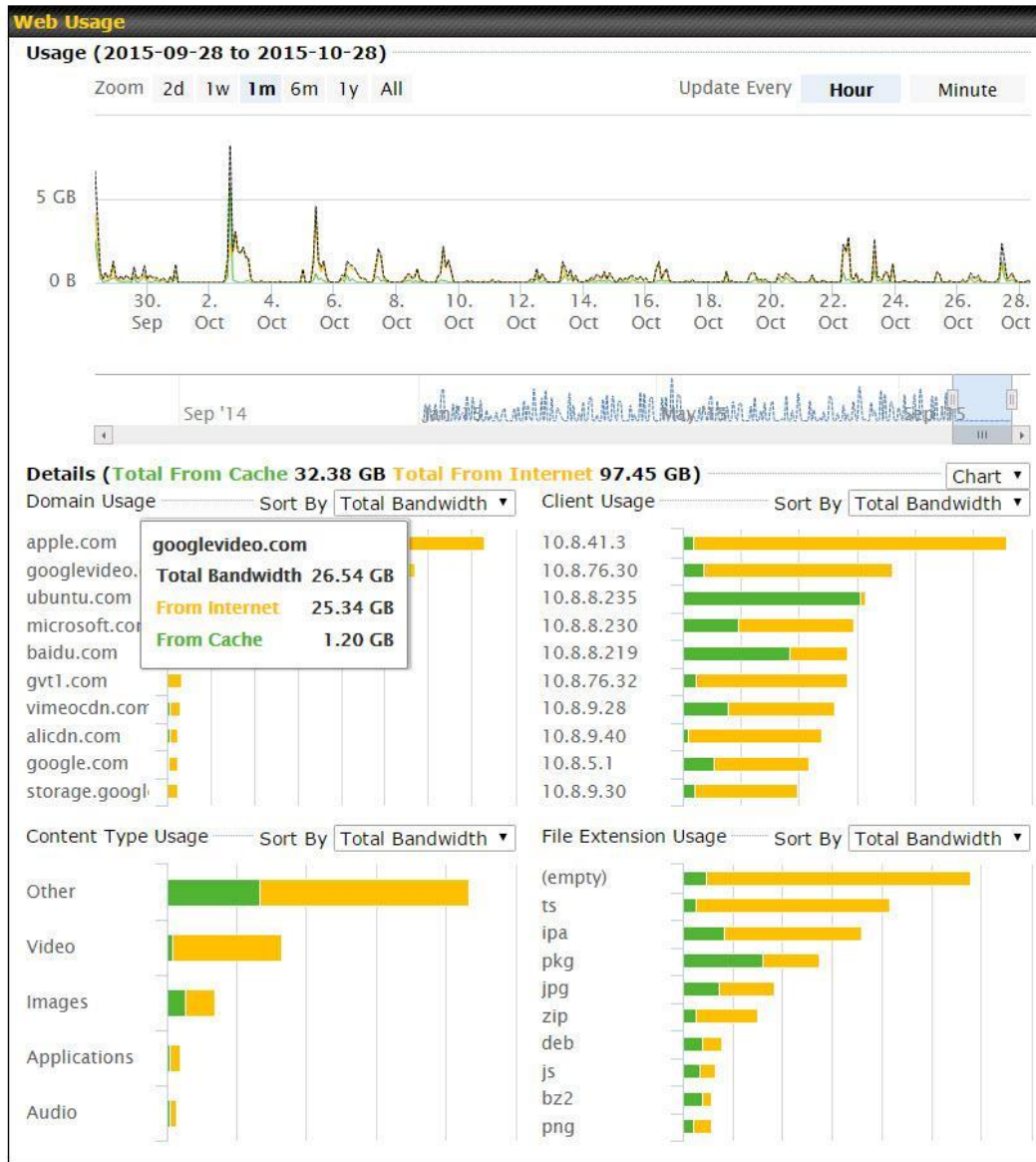

13 Bandwidth Bonding SpeedFusion™ / PepVPN



Pepwave bandwidth bonding SpeedFusion™ is our patented technology that enables our SD-WAN routers to bond multiple Internet connections to increase site-to-site bandwidth and reliability. SpeedFusion functionality securely connects your Pepwave router to another Pepwave or Peplink device (Peplink Balance 210/310/380/580/710/1350 only). Data, voice, or video communications between these locations are kept confidential across the public Internet.

Bandwidth bonding SpeedFusion™ is specifically designed for multi-WAN environments. In case of failures and network congestion at one or more WANs, other WANs can be used to continue carrying the network traffic.

Different models of our SD-WAN routers have different numbers of site-to-site connections allowed. End-users who need to have more site-to-site connections can purchase a SpeedFusion license to increase the number of site-to-site connections allowed.

Pepwave routers can aggregate all WAN connections' bandwidth for routing SpeedFusion™ traffic. Unless all the WAN connections of one site are down, Pepwave routers can keep the VPN up and running.

VPN bandwidth bonding is supported in Firmware 5.1 or above. All available bandwidth will be utilized to establish the VPN tunnel, and all traffic will be load balanced at packet level across all links. VPN bandwidth bonding is enabled by default.

13.1 PepVPN

To configure PepVPN and SpeedFusion, navigate to **Advanced>SpeedFusion™** or **Advanced>PepVPN**.



PepVPN with SpeedFusion™



 InControl management enabled. Settings can now be configured on [InControl](#).

Profile	Remote ID	Remote Address(es)	
 FL Office	8345-5F7A-DE97		 
<input type="button" value="New Profile"/>			

Send All Traffic To
No PepVPN profile selected 

PepVPN
Local ID  MAX_HD2_DEF1 

Link Failure Detection
Link Failure Detection Time  <ul style="list-style-type: none"> <input checked="" type="radio"/> Recommended (Approx. 15 secs) <input type="radio"/> Fast (Approx. 6 secs) <input type="radio"/> Faster (Approx. 2 secs) <input type="radio"/> Extreme (Under 1 sec) <small>Shorter detection time incurs more health checks and higher bandwidth overhead</small>
<input type="button" value="Save"/>

The local LAN subnet and subnets behind the LAN (defined under **Static Route** on the LAN settings page) will be advertised to the VPN. All VPN members (branch offices and headquarters) will be able to route to local subnets.

Note that all LAN subnets and the subnets behind them must be unique. Otherwise, VPN members will not be able to access each other.

All data can be routed over the VPN using the 256-bit AES encryption standard. To configure, navigate to **Advanced>SpeedFusion™** or **Advanced>PepVPN** and click the **New Profile** button to create a new VPN profile (you may have to first save the displayed default profile in order to access the **New Profile** button). Each profile specifies the settings for making VPN connection with one remote Pepwave or Peplink device. Note that available settings vary by model.

A list of defined SpeedFusion connection profiles and a **Link Failure Detection Time** option will be shown. Click the **New Profile** button to create a new VPN connection profile for making a VPN connection to a remote Peplink Balance via the available WAN connections. Each profile is for making a VPN connection with one remote Peplink Balance.

PepVPN Profile					
Name	<input type="text"/>				
Active	<input checked="" type="checkbox"/>				
Encryption	<input checked="" type="radio"/> 256-bit AES <input type="radio"/> OFF				
Authentication	<input checked="" type="radio"/> Remote ID / Pre-shared Key <input type="radio"/> X.509				
Remote ID / Pre-shared Key	<table border="1"> <tr> <th>Remote ID</th> <th>Pre-shared Key</th> </tr> <tr> <td><input type="text"/></td> <td><input type="text"/></td> </tr> </table>	Remote ID	Pre-shared Key	<input type="text"/>	<input type="text"/>
Remote ID	Pre-shared Key				
<input type="text"/>	<input type="text"/>				
NAT Mode	<input type="checkbox"/>				
Remote IP Address / Host Names (Optional)	<input type="text"/> If this field is empty, this field on the remote unit must be filled				
Cost	<input type="text" value="10"/>				
Data Port	<input checked="" type="radio"/> Auto <input type="radio"/> Custom <input type="text"/>				
Bandwidth Limit	<input type="checkbox"/>				
WAN Smoothing	<input type="text" value="Off"/>				
Use IP ToS	<input type="checkbox"/>				
Latency Difference Cutoff	<input type="text" value="500"/> ms				

PepVPN Profile Settings	
Name	This field is for specifying a name to represent this profile. The name can be any combination of alphanumeric characters (0-9, A-Z, a-z), underscores (_), dashes (-), and/or non-leading/trailing spaces ().
Active	When this box is checked, this VPN connection profile will be enabled. Otherwise, it will be disabled.
Encryption	By default, VPN traffic is encrypted with 256-bit AES . If Off is selected on both sides of a VPN connection, no encryption will be applied.
Authentication	Select from By Remote ID Only , Preshared Key , or X.509 to specify the method the Peplink Balance will use to authenticate peers. When selecting By Remote ID Only , be sure to enter a unique peer ID number in the Remote ID field.
Remote ID / Pre-shared Key	This optional field becomes available when Remote ID / Pre-shared Key is selected as the Peplink Balance's VPN Authentication method, as explained above. Pre-shared Key defines the pre-shared key used for this particular VPN connection. The VPN connection's session key will be further protected by the pre-shared key. The connection will be up only if the pre-shared keys on each side match. When the peer is running firmware 5.0+, this setting will be ignored.

	Enter Remote IDs either by typing out each Remote ID and Pre-shared Key, or by pasting a CSV. If you wish to paste a CSV, click the  icon next to the "Remote ID / Preshared Key" setting.
Remote ID/Remote Certificate	These optional fields become available when X.509 is selected as the Peplink Balance's VPN authentication method, as explained above. To authenticate VPN connections using X.509 certificates, copy and paste certificate details into these fields. To get more information on a listed X.509 certificate, click the Show Details link below the field.
Allow Shared Remote ID	When this option is enabled, the router will allow multiple peers to run using the same remote ID.
NAT Mode	Check this box to allow the local DHCP server to assign an IP address to the remote peer. When NAT Mode is enabled, all remote traffic over the VPN will be tagged with the assigned IP address using network address translation.
Remote IP Address / Host Names (Optional)	<p>If NAT Mode is not enabled, you can enter a remote peer's WAN IP address or hostname(s) here. If the remote uses more than one address, enter only one of them here. Multiple hostnames are allowed and can be separated by a space character or carriage return. Dynamic-DNS host names are also accepted.</p> <p>This field is optional. With this field filled, the Peplink Balance will initiate connection to each of the remote IP addresses until it succeeds in making a connection. If the field is empty, the Peplink Balance will wait for connection from the remote peer. Therefore, at least one of the two VPN peers must specify this value. Otherwise, VPN connections cannot be established.</p>
Cost	Define path cost for this profile. OSPF will determine the best route through the network using the assigned cost. Default: 10
Data Port	This field is used to specify a UDP port number for transporting outgoing VPN data. If Default is selected, UDP port 4500 will be used. Port 32015 will be used if the remote unit uses Firmware prior to version 5.4 or if port 4500 is unavailable. If Custom is selected, enter an outgoing port number from 1 to 65535.
Bandwidth Limit	Define maximum download and upload speed to each individual peer. This functionality requires the peer to use PepVPN version 4.0.0 or above.
Cost	Define path cost for this profile. OSPF will determine the best route through the network using the assigned cost. Default: 10
WAN Smoothing^A	Select the degree to which WAN Smoothing will be implemented across your WAN links.
Use IP ToS	Checking this button enables the use of IP ToS header field.

Latency Difference Cutoff

Traffic will be stopped for links that exceed the specified millisecond value with respect to the lowest latency link. (e.g. Lowest latency is 100ms, a value of 500ms means links with latency 600ms or more will not be used)

^A - Advanced feature, please click the button on the top right-hand corner to activate. To enable Layer 2 Bridging between PepVPN profiles, navigate to **Network>LAN>Basic Settings>*LAN Profile Name*** and refer to instructions in section 9.1

WAN Connection Priority					
	Priority	Direction	Connect to Remote	Cut-off latency (ms)	Suspension Time after Packet Loss (ms)
1. WAN 1	1 (Highest) ▼	Up/Down ▼	All ▼	<input type="text"/>	<input type="text"/>
2. WAN 2	1 (Highest) ▼	Up/Down ▼	All ▼	<input type="text"/>	<input type="text"/>
3. Wi-Fi WAN	1 (Highest) ▼	Up/Down ▼	All ▼	<input type="text"/>	<input type="text"/>
4. Cellular 1	1 (Highest) ▼	Up/Down ▼	All ▼	<input type="text"/>	<input type="text"/>
5. Cellular 2	1 (Highest) ▼	Up/Down ▼	All ▼	<input type="text"/>	<input type="text"/>
6. USB	1 (Highest) ▼	Up/Down ▼	All ▼	<input type="text"/>	<input type="text"/>

WAN Connection Priority

WAN Connection Priority

If your device supports it, you can specify the priority of WAN connections to be used for making VPN connections. WAN connections set to **OFF** will never be used. Only available WAN connections with the highest priority will be used.

To enable asymmetric connections, connection mapping to remote WANs, cut-off latency, and packet loss suspension time, click the button.

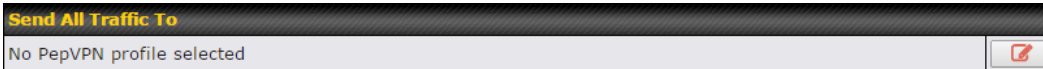

Send All Traffic To

This feature allows you to redirect all traffic to a specified PepVPN connection. Click the button to select your connection and the following menu will appear:

Send All Traffic

Send All Traffic To ? Balance 2942-1257-1241

DNS Server
8.8.8.8
8.8.4.4

Backup Site Balance-4810-1825-068E-4810

DNS Server
8.8.8.8
8.8.4.4

You could also specify a DNS server to resolve incoming DNS requests. Click the checkbox next to **Backup Site** to designate a backup SpeedFusion profile that will take over, should the main PepVPN connection fail.

Outbound Policy

According to custom rules

PepVPN Outbound Custom Rules

Service	Algorithm	Source	Destination	Protocol
		(Auto)		

Outbound Policy/PepVPN Outbound Custom Rules

Some models allow you to set outbound policy and custom outbound rules from **Advanced>PepVPN**. See **Section 14** for more information on outbound policy settings.

PepVPN Local ID

Local ID ? MAX_HD2_8D1C

PepVPN Local ID

The local ID is a text string to identify this local unit when establishing a VPN connection. When creating a profile on a remote unit, this local ID must be entered in the remote unit's **Remote ID** field. Click the icon to edit **Local ID**.

PepVPN Settings ?

Handshake Port Default Custom

Backward Compatibility High (firmware 5.3+) Latest (firmware 6.2+)

Link Failure Detection Time ? Recommended (Approx. 15 secs)
 Fast (Approx. 6 secs)
 Faster (Approx. 2 secs)
 Extreme (Under 1 sec)
 Shorter detection time incurs more health checks and higher bandwidth overhead

PepVPN Settings	
Handshake Port^A	To designate a custom handshake port (TCP), click the custom radio button and enter the port number you wish to designate.
Backward Compatibility	Determine the level of backward compatibility needed for PepVPN tunnels. The use of the Latest setting is recommended as it will improve the performance and resilience of SpeedFusion connections.
Link Failure Detection Time	<p>The bonded VPN can detect routing failures on the path between two sites over each WAN connection. Failed WAN connections will not be used to route VPN traffic. Health check packets are sent to the remote unit to detect any failure. The more frequently checks are sent, the shorter the detection time, although more bandwidth will be consumed.</p> <p>When Recommended (default) is selected, a health check packet is sent every five seconds, and the expected detection time is 15 seconds.</p> <p>When Fast is selected, a health check packet is sent every three seconds, and the expected detection time is six seconds.</p> <p>When Faster is selected, a health check packet is sent every second, and the expected detection time is two seconds.</p> <p>When Extreme is selected, a health check packet is sent every 0.1 second, and the expected detection time is less than one second.</p>

^A - Advanced feature, please click the button on the top right-hand corner to activate.

Important Note

PepLink proprietary SpeedFusion™ uses TCP port 32015 and UDP port 4500 for establishing VPN connections. If you have a firewall in front of your Pepwave devices, you will need to add firewall rules for these ports and protocols to allow inbound and outbound traffic to pass through the firewall.

Tip

Want to know more about VPN sub-second session failover? Visit our YouTube Channel for a video tutorial!

<http://youtu.be/TLQgdpPSY88>

13.2 The Pepwave Router Behind a NAT Router

Pepwave routers support establishing SpeedFusion™ over WAN connections which are behind a NAT (network address translation) router.

To enable a WAN connection behind a NAT router to accept VPN connections, you can configure the NAT router in front of the WAN connection to inbound port-forward TCP port 32015 to the Pepwave router.

If one or more WAN connections on Unit A can accept VPN connections (by means of port forwarding or not), while none of the WAN connections on the peer Unit B can do so, you should enter all of Unit A's public IP addresses or hostnames into Unit B's **Remote IP Addresses / Host Names** field. Leave the field in Unit A blank. With this setting, a SpeedFusion™ connection can be set up and all WAN connections on both sides will be utilized.

See the following diagram for an example of this setup in use:

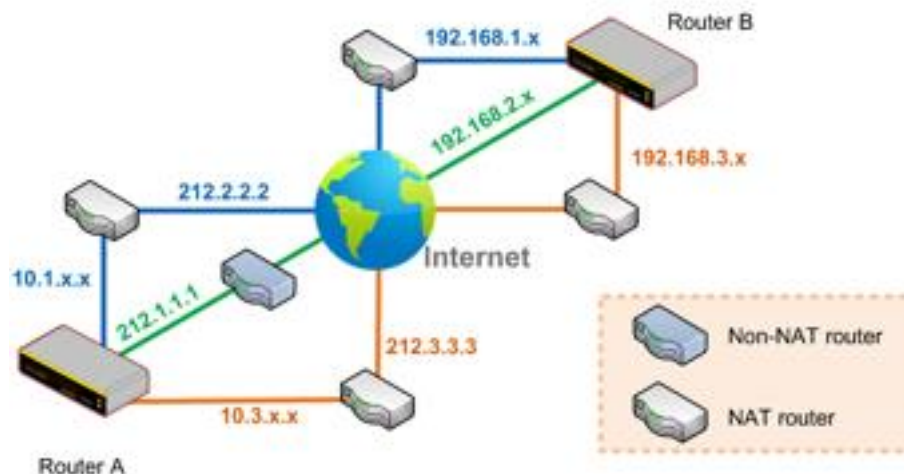

One of the WANs connected to Router A is non-NAT'd (212.1.1.1). The rest of the WANs connected to Router A and all WANs connected to Router B are NAT'd. In this case, the **Peer IP Addresses / Host Names** field for Router B should be filled with all of Router A's hostnames or public IP addresses (i.e., 212.1.1.1, 212.2.2.2, and 212.3.3.3), and the field in Router A can be left blank. The two NAT routers on WAN1 and WAN3 connected to Router A should inbound port-forward TCP port 32015 to Router A so that all WANs will be utilized in establishing the VPN.

13.3 SpeedFusion™ Status

SpeedFusion™ status is shown in the **Dashboard**. The connection status of each connection profile is shown as below.

SpeedFusion™		Status
FL Office		Established
NY Office		Established

After clicking the **Status** button at the top right corner of the SpeedFusion™ table, you will be forwarded to **Status>SpeedFusion™**, where you can view subnet and WAN connection information for each VPN peer. Please refer to **Section 22.6** for details.

IP Subnets Must Be Unique Among VPN Peers

The entire interconnected SpeedFusion™ network is a single non-NAT IP network. Avoid duplicating subnets in your sites to prevent connectivity problems when accessing those subnets.

14 IPsec VPN

IPsec VPN functionality securely connects one or more branch offices to your company's main headquarters or to other branches. Data, voice, and video communications between these locations are kept safe and confidential across the public Internet.

IPsec VPN on Pepwave routers is specially designed for multi-WAN environments. For instance, if a user sets up multiple IPsec profiles for a multi-WAN environment and WAN1 is connected and healthy, IPsec traffic will go through this link. However, should unforeseen problems (e.g., unplugged cables or ISP problems) cause WAN1 to go down, our IPsec implementation will make use of WAN2 and WAN3 for failover.

14.1 IPsec VPN Settings

Many Pepwave products can make multiple IPsec VPN connections with Peplink, Pepwave, Cisco, and Juniper routers. Note that all LAN subnets and the subnets behind them must be unique. Otherwise, VPN members will not be able to access each other. All data can be routed over the VPN with a selection of encryption standards, such as 3DES, AES-128, and AES-256. To configure IPsec VPN on Pepwave devices that support it, navigate to **Advanced>IPsec**

VPN.

NAT-Traversal	Enabled	
IPsec VPN Profiles	Remote Networks	
No IPsec VPN Profile Defined.		
New Profile		

Pepwave MAX IPsec only supports network-to-network connection with Cisco, Juniper or Pepwave MAX devices.

A **NAT-Traversal** option and list of defined **IPsec VPN** profiles will be shown. **NAT-Traversal** should be enabled if your system is behind a NAT router. Click the **New Profile** button to create new IPsec VPN profiles that make VPN connections to remote Pepwave, Cisco, or Juniper routers via available WAN connections. To edit any of the profiles, click on its associated connection name in the leftmost column.

IPsec VPN Profile	
--------------------------	---

Name	Profile 1								
Active	<input checked="" type="checkbox"/>								
Connect Upon Disconnection of	<input checked="" type="checkbox"/>	WAN 2							
Remote Gateway IP Address / Host Name	<input type="checkbox"/>	12.12.12.12							
Local Networks	<input type="checkbox"/>	<p>Propose the following networks to remote gateway:</p> <p><input type="checkbox"/> 172.16.1.1/24</p> <p><input type="checkbox"/> 172.16.2.1/24</p> <p><input type="checkbox"/> 172.16.3.1/24</p> <p><input checked="" type="checkbox"/> 10.10.0.1/32</p> <p><input checked="" type="checkbox"/> 192.168.10.0/24</p> <p><input checked="" type="checkbox"/> 192.168.11.0/24</p> <p><input type="checkbox"/> <input type="text"/></p> <p>Apply the following NAT policies:</p> <p><input checked="" type="checkbox"/> 172.16.1.0/24 <input checked="" type="checkbox"/> 192.168.10.0/24</p> <p><input checked="" type="checkbox"/> 172.16.2.0/24 <input checked="" type="checkbox"/> 10.10.0.1/32</p> <p><input checked="" type="checkbox"/> 172.16.3.11/32 <input checked="" type="checkbox"/> 192.168.11.101/32</p> <p><input checked="" type="checkbox"/> 172.16.3.21/32 <input checked="" type="checkbox"/> 192.168.11.201/32</p> <p><input type="checkbox"/> Local Network <input checked="" type="checkbox"/> NAT Network</p>							
Remote Networks	<table border="1"> <thead> <tr> <th>Network</th> <th>Subnet Mask</th> <th></th> </tr> </thead> <tbody> <tr> <td><input type="text" value="192.167.11.193"/></td> <td><input type="text" value="255.255.255.0 (/24)"/></td> <td><input type="button" value="+"/></td> </tr> </tbody> </table>	Network	Subnet Mask		<input type="text" value="192.167.11.193"/>	<input type="text" value="255.255.255.0 (/24)"/>	<input type="button" value="+"/>		
Network	Subnet Mask								
<input type="text" value="192.167.11.193"/>	<input type="text" value="255.255.255.0 (/24)"/>	<input type="button" value="+"/>							
Authentication	<input checked="" type="radio"/> Preshared Key <input type="radio"/> X.509 Certificate								
Mode	<input checked="" type="radio"/> Main Mode (All WANs need to have Static IP) <input type="radio"/> Aggressive Mode								
Force UDP Encapsulation	<input type="checkbox"/>								
Preshared Key	<input type="text" value="....."/> <input checked="" type="checkbox"/> Hide Characters								
Local ID	<input type="checkbox"/>	<input type="text"/>							
Remote ID	<input type="checkbox"/>	<input type="text"/>							
Phase 1 (IKE) Proposal	1 <input type="text" value="AES-256 & SHA1"/> 2 <input type="text" value="-----"/>								
Phase 1 DH Group	<input checked="" type="checkbox"/> Group 2: MODP 1024 <input type="checkbox"/> Group 5: MODP 1536								
Phase 1 SA Lifetime	<input type="text" value="3600"/>	seconds	<input type="button" value="Default"/>						
Phase 2 (ESP) Proposal	1 <input type="text" value="AES-256 & SHA1"/> 2 <input type="text" value="-----"/>								
Phase 2 PFS Group	<input checked="" type="radio"/> None <input type="radio"/> Group 2: MODP 1024 <input type="radio"/> Group 5: MODP 1536								
Phase 2 SA Lifetime	<input type="text" value="28800"/>	seconds	<input type="button" value="Default"/>						

IPsec VPN Settings	
Name	This field is for specifying a local name to represent this connection profile.
Active	When this box is checked, this IPsec VPN connection profile will be enabled. Otherwise, it will be disabled.
Connect Upon Disconnection of	Check this box and select a WAN to connect to this VPN automatically when the specified WAN is disconnected.
Remote Gateway IP Address / Host Name	Enter the remote peer's public IP address. For Aggressive Mode , this is optional.
Local Networks	<p>Enter the local LAN subnets here. If you have defined static routes, they will be shown here.</p> <p>Using NAT, you can map a specific local network / IP address to another, and the packets received by remote gateway will appear to be coming from the mapped network / IP address. This allow you to establish IPsec connection to a remote site that has one or more subnets overlapped with local site.</p> <p>Two types of NAT policies can be defined:</p> <p>One-to-One NAT policy: if the defined subnet in Local Network and NAT Network has the same size, for example, policy "192.168.50.0/24 > 172.16.1.0/24" will translate the local IP address 192.168.50.10 to 172.16.1.10 and 192.168.50.20 to 172.16.1.20. This is a bidirectional mapping which means clients in remote site can initiate connection to the local clients using the mapped address too.</p> <p>Many-to-One NAT policy: if the defined NAT Network on the right hand side is an IP address (or having a network prefix /32), for example, policy "192.168.1.0/24 > 172.168.50.1/32" will translate all clients in 192.168.1.0/24 network to 172.168.50.1. This is a unidirectional mapping which means clients in remote site will not be able to initiate connection to the local clients.</p>
Remote Networks	Enter the LAN and subnets that are located at the remote site here.
Authentication	To access your VPN, clients will need to authenticate by your choice of methods. Choose between the Preshared Key and X.509 Certificate methods of authentication.
Mode	Choose Main Mode if both IPsec peers use static IP addresses. Choose Aggressive Mode if one of the IPsec peers uses dynamic IP addresses.
Force UDP Encapsulation	For forced UDP encapsulation regardless of NAT-traversal, tick this checkbox.

Pre-shared Key	This defines the peer authentication pre-shared key used to authenticate this VPN connection. The connection will be up only if the pre-shared keys on each side match.
Remote Certificate (pem encoded)	Available only when X.509 Certificate is chosen as the Authentication method, this field allows you to paste a valid X.509 certificate.
Local ID	In Main Mode , this field can be left blank. In Aggressive Mode , if Remote Gateway IP Address is filled on this end and the peer end, this field can be left blank. Otherwise, this field is typically a U-FQDN.
Remote ID	In Main Mode , this field can be left blank. In Aggressive Mode , if Remote Gateway IP Address is filled on this end and the peer end, this field can be left blank. Otherwise, this field is typically a U-FQDN.
Phase 1 (IKE) Proposal	In Main Mode , this allows setting up to six encryption standards, in descending order of priority, to be used in initial connection key negotiations. In Aggressive Mode , only one selection is permitted.
Phase 1 DH Group	This is the Diffie-Hellman group used within IKE. This allows two parties to establish a shared secret over an insecure communications channel. The larger the group number, the higher the security. Group 2: 1024-bit is the default value. Group 5: 1536-bit is the alternative option.
Phase 1 SA Lifetime	This setting specifies the lifetime limit of this Phase 1 Security Association. By default, it is set at 3600 seconds.
Phase 2 (ESP) Proposal	In Main Mode , this allows setting up to six encryption standards, in descending order of priority, to be used for the IP data that is being transferred. In Aggressive Mode , only one selection is permitted.
Phase 2 PFS Group	Perfect forward secrecy (PFS) ensures that if a key was compromised, the attacker will be able to access only the data protected by that key. None - Do not request for PFS when initiating connection. However, since there is no valid reason to refuse PFS, the system will allow the connection to use PFS if requested by the remote peer. This is the default value. Group 2: 1024-bit Diffie-Hellman group. The larger the group number, the higher the security. Group 5: 1536-bit is the third option.
Phase 2 SA Lifetime	This setting specifies the lifetime limit of this Phase 2 Security Association. By default, it is set at 28800 seconds.

WAN Connection Priority	
Priority	WAN Selection
1	WAN 1
2	-----

WAN Connection Priority

WAN Connection Select the appropriate WAN connection from the drop-down menu.

15 Outbound Policy Management

Pepwave routers can flexibly manage and load balance outbound traffic among WAN connections.

Important Note

Outbound policy is applied only when more than one WAN connection is active.

The settings for managing and load balancing outbound traffic are located at **Advanced>Outbound Policy** or **Advanced>PepVPN**, depending on the model.

Outbound Policy ?

Custom ✎

Rules (Drag and drop rows to change rule order) ?

Service	Algorithm	Source	Destination	Protocol / Port	
HTTPS Persistence	Persistence (Src) (Auto)	Any	Any	TCP 443	✖
Default	(Auto)				

15.1 Outbound Policy

Outbound policies for managing and load balancing outbound traffic are located at **Network>Outbound Policy>** or **Advanced>PepVPN>Outbound Policy**.

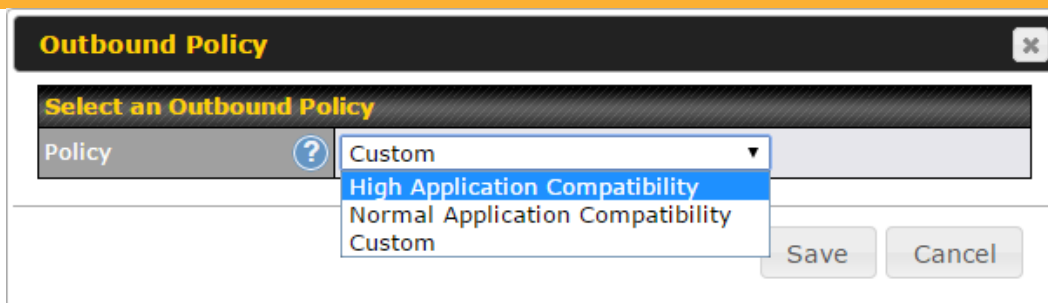

There are three main selections for the outbound traffic policy:

- High Application Compatibility
- Normal Application Compatibility
- Custom

Note that some Pepwave routers provide only the **Send All Traffic To** setting here. See **Section 12.1** for details.

Outbound Policy Settings	
High Application Compatibility	Outbound traffic from a source LAN device is routed through the same WAN connection regardless of the destination Internet IP address and protocol. This option provides the highest application compatibility.
Normal Application Compatibility	Outbound traffic from a source LAN device to the same destination Internet IP address will be routed through the same WAN connection persistently, regardless of protocol. This option provides high compatibility to most applications, and users still benefit from WAN link load balancing when multiple Internet servers are accessed.
Custom	Outbound traffic behavior can be managed by defining rules in a custom rule table. A default rule can be defined for connections that cannot be matched with any of the rules.

The default policy is **Normal Application Compatibility**.

Tip

Want to know more about creating outbound rules? Visit our YouTube Channel for a video tutorial!

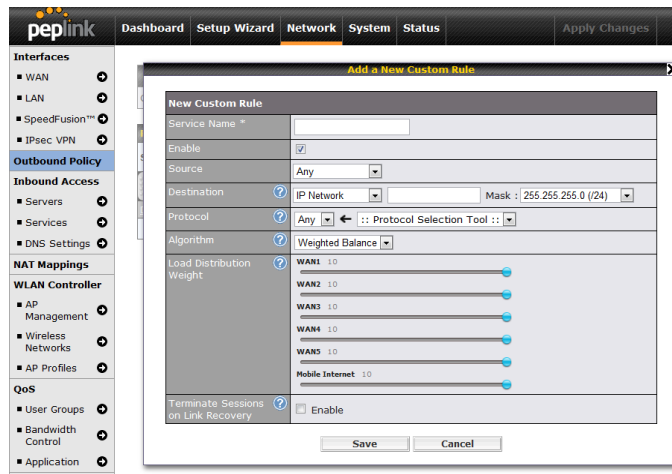

http://youtu.be/rKH4AS_bQnE

15.2 Custom Rules for Outbound Policy

Click  in the **Outbound Policy** form. Choose **Custom** and press the **Save** button.

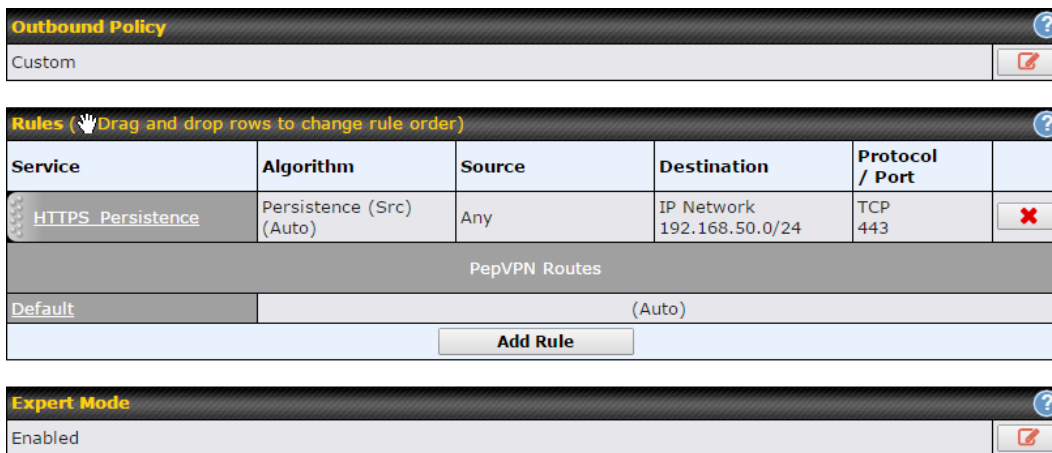

15.2.1 Algorithm: Weighted Balance

This setting specifies the ratio of WAN connection usage to be applied on the specified IP protocol and port. This setting is applicable only when **Algorithm** is set to **Weighted Balance**.

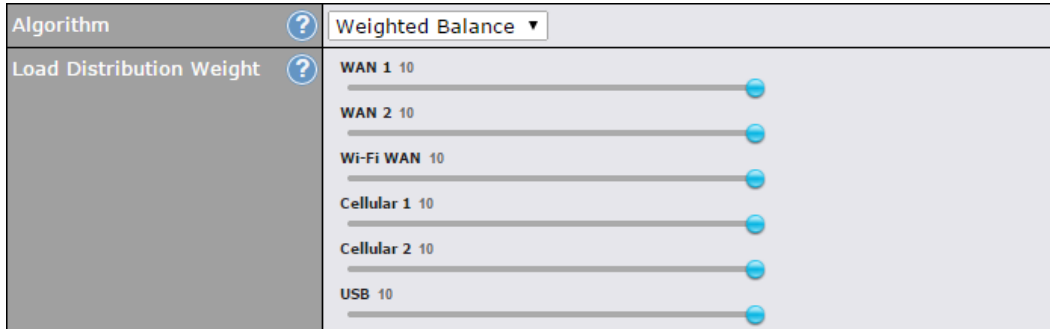

The amount of matching traffic that is distributed to a WAN connection is proportional to the weight of the WAN connection relative to the total weight. Use the sliders to change each WAN's weight.

For example, with the following weight settings:

- Ethernet WAN1: 10
- Ethernet WAN2: 10
- Wi-Fi WAN: 10
- Cellular 1: 10
- Cellular 2: 10
- USB: 10

Total weight is $60 = (10 + 10 + 10 + 10 + 10 + 10)$.

Matching traffic distributed to Ethernet WAN1 is $16.7\% = (10 / 60) \times 100\%$.

Matching traffic distributed to Ethernet WAN2 is $16.7\% = (10 / 60) \times 100\%$.

Matching traffic distributed to Wi-Fi WAN is $16.7\% = (10 / 60) \times 100\%$.

Matching traffic distributed to Cellular 1 is $16.7\% = (10 / 60) \times 100\%$.

Matching traffic distributed to Cellular 2 is $16.7\% = (10 / 60) \times 100\%$.

Matching traffic distributed to USB is $16.7\% = (10 / 60) \times 100\%$.

15.2.2 Algorithm: Persistence

The configuration of persistent services is the solution to the few situations where link load distribution for Internet services is undesirable. For example, for security reasons, many e-banking and other secure websites terminate the session when the client computer’s Internet IP address changes mid-session.

In general, different Internet IP addresses represent different computers. The security concern is that an IP address change during a session may be the result of an unauthorized intrusion attempt. Therefore, to prevent damages from the potential intrusion, the session is terminated upon the detection of an IP address change.

Pepwave routers can be configured to distribute data traffic across multiple WAN connections. Also, the Internet IP depends on the WAN connections over which communication actually takes place. As a result, a LAN client computer behind the Pepwave router may communicate using multiple Internet IP addresses. For example, a LAN client computer behind a Pepwave router with three WAN connections may communicate on the Internet using three different IP addresses.

With the persistence feature, rules can be configured to enable client computers to persistently utilize the same WAN connections for e-banking and other secure websites. As a result, a client computer will communicate using one IP address, eliminating the issues mentioned above.

Algorithm	<input type="text" value="Persistence"/>
Persistence Mode	<input checked="" type="radio"/> By Source <input type="radio"/> By Destination
Load Distribution	<input type="radio"/> Auto <input checked="" type="radio"/> Custom
Load Distribution Weight	WAN 1 10 <input type="range" value="10"/> WAN 2 10 <input type="range" value="10"/> Wi-Fi WAN 10 <input type="range" value="10"/> Cellular 1 10 <input type="range" value="10"/> Cellular 2 10 <input type="range" value="10"/> USB 10 <input type="range" value="10"/>

There are two persistent modes: **By Source** and **By Destination**.

By Source:	The same WAN connection will be used for traffic matching the rule and originating from the same machine, regardless of its destination. This option will provide the highest level of application compatibility.
-------------------	---

By Destination:	The same WAN connection will be used for traffic matching the rule, originating from the same machine, and going to the same destination. This option can better distribute loads to WAN connections when there are only a few client machines.
------------------------	---

The default mode is **By Source**. When there are multiple client requests, they can be distributed (persistently) to WAN connections with a weight. If you choose **Auto** in **Load Distribution**, the weights will be automatically adjusted according to each WAN's **Downstream Bandwidth** which is specified in the WAN settings page). If you choose **Custom**, you can customize the weight of each WAN manually by using the sliders.

15.2.3 Algorithm: Enforced

This setting specifies the WAN connection usage to be applied on the specified IP protocol and port. This setting is applicable only when **Algorithm** is set to **Enforced**.

Algorithm	Enforced	
Enforced Connection	<div style="border: 1px solid #ccc; padding: 2px;"> WAN: WAN 1 WAN: WAN 1 WAN: WAN 2 WAN: Wi-Fi WAN WAN: Cellular 1 WAN: Cellular 2 WAN: USB VPN: Connection 1 </div>	<input type="button" value="Save"/> <input type="button" value="Cancel"/>

Matching traffic will be routed through the specified WAN connection, regardless of the health check status of the WAN connection. Starting from Firmware 5.2, outbound traffic can be enforced to go through a specified SpeedFusion™ connection.

15.2.4 Algorithm: Priority

This setting specifies the priority of the WAN connections used to route the specified network service. The highest priority WAN connection available will always be used for routing the specified type of traffic. A lower priority WAN connection will be used only when all higher priority connections have become unavailable.

Algorithm	Priority																	
Priority Order	<table border="1" style="width: 100%;"> <tr> <td style="background-color: #f0f0f0;">Highest Priority</td> <td>Not In Use</td> </tr> <tr> <td>WAN: WAN 1</td> <td>VPN: Connection 1</td> </tr> <tr> <td>WAN: WAN 2</td> <td></td> </tr> <tr> <td>WAN: Wi-Fi WAN</td> <td></td> </tr> <tr> <td>WAN: Cellular 1</td> <td></td> </tr> <tr> <td>WAN: Cellular 2</td> <td></td> </tr> <tr> <td>WAN: USB</td> <td></td> </tr> <tr> <td style="background-color: #f0f0f0;">Lowest Priority</td> <td></td> </tr> </table>	Highest Priority	Not In Use	WAN: WAN 1	VPN: Connection 1	WAN: WAN 2		WAN: Wi-Fi WAN		WAN: Cellular 1		WAN: Cellular 2		WAN: USB		Lowest Priority		
Highest Priority	Not In Use																	
WAN: WAN 1	VPN: Connection 1																	
WAN: WAN 2																		
WAN: Wi-Fi WAN																		
WAN: Cellular 1																		
WAN: Cellular 2																		
WAN: USB																		
Lowest Priority																		
Terminate Sessions on Link Recovery	<input type="checkbox"/> Enable																	

Starting from Firmware 5.2, outbound traffic can be prioritized to go through SpeedFusion™ connection(s). By default, VPN connections are not included in the priority list.

Tip

Configure multiple distribution rules to accommodate different kinds of services.

15.2.5 Algorithm: Overflow

The traffic matching this rule will be routed through the healthy WAN connection that has the highest priority and is not in full load. When this connection gets saturated, new sessions will be routed to the next healthy WAN connection that is not in full load.

Algorithm	?	Overflow								
Overflow Order	?	<table border="1"> <tr><td>Highest Priority</td></tr> <tr><td>WAN: WAN 1</td></tr> <tr><td>WAN: WAN 2</td></tr> <tr><td>WAN: Wi-Fi WAN</td></tr> <tr><td>WAN: Cellular 1</td></tr> <tr><td>WAN: Cellular 2</td></tr> <tr><td>WAN: USB</td></tr> <tr><td>Lowest Priority</td></tr> </table>	Highest Priority	WAN: WAN 1	WAN: WAN 2	WAN: Wi-Fi WAN	WAN: Cellular 1	WAN: Cellular 2	WAN: USB	Lowest Priority
Highest Priority										
WAN: WAN 1										
WAN: WAN 2										
WAN: Wi-Fi WAN										
WAN: Cellular 1										
WAN: Cellular 2										
WAN: USB										
Lowest Priority										

Drag and drop to specify the order of WAN connections to be used for routing traffic. Only the highest priority healthy connection that is not in full load will be used.

15.2.6 Algorithm: Least Used

Algorithm	?	Least Used
Connection		<input checked="" type="checkbox"/> WAN 1 <input checked="" type="checkbox"/> WAN 2 <input checked="" type="checkbox"/> Wi-Fi WAN <input type="checkbox"/> Cellular 1 <input type="checkbox"/> Cellular 2 <input type="checkbox"/> USB

The traffic matching this rule will be routed through the healthy WAN connection that is selected in **Connection** and has the most available download bandwidth. The available download bandwidth of a WAN connection is calculated from the total download bandwidth specified on the WAN settings page and the current download usage. The available bandwidth and WAN selection is determined every time an IP session is made.

15.2.7 Algorithm: Lowest Latency

Algorithm	? Lowest Latency ▾ <small>Note: Use of Lowest Latency will incur additional network usage.</small>
Connection	<input checked="" type="checkbox"/> WAN 1 <input checked="" type="checkbox"/> WAN 2 <input checked="" type="checkbox"/> Wi-Fi WAN <input type="checkbox"/> Cellular 1 <input type="checkbox"/> Cellular 2 <input type="checkbox"/> USB

The traffic matching this rule will be routed through the healthy WAN connection that is selected in **Connection** and has the lowest latency. Latency checking packets are issued periodically to a nearby router of each WAN connection to determine its latency value. The latency of a WAN is the packet round trip time of the WAN connection. Additional network usage may be incurred as a result.

Tip

Help [Close](#)

This table allows you to fine tune how the outbound traffic should be distributed to the WAN connections.

Click the *Add Rule* button to add a new rule. Click the *X* button to remove a rule. Drag a rule to promote or demote its precedence. A higher position of a rule signifies a higher precedence. You may change the default outbound policy behavior by clicking the *Default* link.

If you require advanced control of PepVPN traffic, [turn on Expert Mode](#).

The roundtrip time of a 6M down/640k uplink can be higher than that of a 2M down/2M up link because the overall round trip time is lengthened by its slower upload bandwidth, despite its higher downlink speed. Therefore, this algorithm is good for two scenarios:

- All WAN connections are symmetric; or
- A latency sensitive application must be routed through the lowest latency WAN, regardless of the WAN's available bandwidth.

15.2.8 Expert Mode

Expert Mode is available on some Pepwave routers for use by advanced users. To enable the feature, click on the help icon and click **turn on Expert Mode**.

In Expert Mode, a new special rule, **SpeedFusion™ Routes**, is displayed in the **Custom Rules** table. This rule represents all SpeedFusion™ routes learned from remote VPN peers. By default, this bar is on the top of all custom rules. This position means that traffic for remote VPN subnets will be routed to the corresponding VPN peer. You can create custom **Priority** or **Enforced** rules and move them above the bar to override the SpeedFusion™ routes.

Upon disabling Expert Mode, all rules above the bar will be removed.

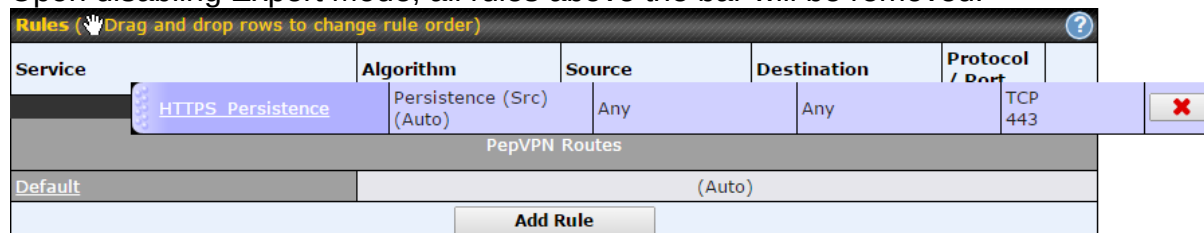

16 Inbound Access

16.1 Port Forwarding Service

Pepwave routers can act as a firewall that blocks, by default, all inbound access from the Internet. By using port forwarding, Internet users can access servers behind the Pepwave router. Inbound port forwarding rules can be defined at **Advanced>Port Forwarding**.

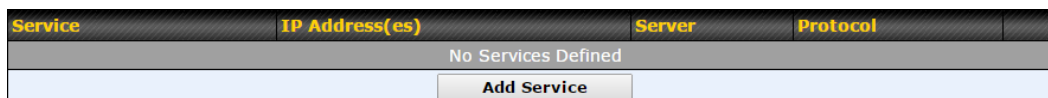

To define a new service, click **Add Service**.

Enable	<input checked="" type="radio"/> Yes <input type="radio"/> No																												
Service Name	Service_1																												
IP Protocol	TCP <input type="button" value="←"/> :: Protocol Selection Tool :: <input type="button" value="▼"/>																												
Port	Any Port <input type="button" value="▼"/>																												
Inbound IP Address(es) <small>(Require at least one IP address)</small>	<table border="1"> <thead> <tr> <th colspan="2">Connection / IP Address(es)</th> <th>All</th> <th>Clear</th> </tr> </thead> <tbody> <tr> <td><input checked="" type="checkbox"/> WAN 1</td> <td><input checked="" type="checkbox"/> 10.88.3.158 (Interface IP)</td> <td></td> <td></td> </tr> <tr> <td><input type="checkbox"/> WAN 2</td> <td></td> <td></td> <td></td> </tr> <tr> <td><input type="checkbox"/> Wi-Fi WAN</td> <td></td> <td></td> <td></td> </tr> <tr> <td><input type="checkbox"/> Cellular 1</td> <td></td> <td></td> <td></td> </tr> <tr> <td><input type="checkbox"/> Cellular 2</td> <td></td> <td></td> <td></td> </tr> <tr> <td><input type="checkbox"/> USB</td> <td></td> <td></td> <td></td> </tr> </tbody> </table>	Connection / IP Address(es)		All	Clear	<input checked="" type="checkbox"/> WAN 1	<input checked="" type="checkbox"/> 10.88.3.158 (Interface IP)			<input type="checkbox"/> WAN 2				<input type="checkbox"/> Wi-Fi WAN				<input type="checkbox"/> Cellular 1				<input type="checkbox"/> Cellular 2				<input type="checkbox"/> USB			
Connection / IP Address(es)		All	Clear																										
<input checked="" type="checkbox"/> WAN 1	<input checked="" type="checkbox"/> 10.88.3.158 (Interface IP)																												
<input type="checkbox"/> WAN 2																													
<input type="checkbox"/> Wi-Fi WAN																													
<input type="checkbox"/> Cellular 1																													
<input type="checkbox"/> Cellular 2																													
<input type="checkbox"/> USB																													
Server IP Address	120.78.95.7																												

Port Forwarding Settings

Enable

This setting specifies whether the inbound service takes effect. When **Enable** is checked, the inbound service takes effect: traffic is matched and actions are taken by the Pepwave router based on the other parameters of the rule. When this setting is disabled, the inbound service does not take effect: the Pepwave router disregards the other parameters of the rule.

Service Name

This setting identifies the service to the system administrator. Valid values for this setting consist of only alphanumeric and underscore “_” characters.

IP Protocol

The **IP Protocol** setting, along with the **Port** setting, specifies the protocol of the service as TCP, UDP, ICMP, or IP. Traffic that is received by the Pepwave router via the specified protocol at the specified port(s) is forwarded to the LAN hosts specified by the **Servers** setting. Please see below for details on the **Port** and **Servers** settings. Alternatively, the **Protocol Selection Tool** drop-down menu can be used to automatically fill in the protocol and a single port number of common Internet services (e.g. HTTP, HTTPS, etc.). After selecting an item from the **Protocol Selection Tool** drop-down menu, the protocol and port number remain manually modifiable.

Port

The **Port** setting specifies the port(s) that correspond to the service, and can be configured to behave in one of the following manners:

Any Port, Single Port, Port Range, Port Map, and Range Mapping

Port	?	Any Port
------	---	----------

Any Port: all traffic that is received by the Pepwave router via the specified protocol is forwarded to the servers specified by the **Servers** setting. For example, with **IP Protocol** set to **TCP**, and **Port** set to **Any Port**, all TCP traffic is forwarded to the configured servers.

Port	?	Single Port	Service Port: 80
------	---	-------------	------------------

Single Port: traffic that is received by the Pepwave router via the specified protocol at the specified port is forwarded via the same port to the servers specified by the **Servers** setting. For example, with **IP Protocol** set to **TCP**, and **Port** set to **Single Port** and **Service Port** 80, TCP traffic received on port 80 is forwarded to the configured servers via port 80.

Port	?	Port Range	Service Ports: 80 - 88
------	---	------------	------------------------

Port Range: traffic that is received by the Pepwave router via the specified protocol at the specified port range is forwarded via the same respective ports to the LAN hosts specified by the **Servers** setting. For example, with **IP Protocol** set to **TCP**, and **Port** set to **Port Range** and **Service Ports** 80-88, TCP traffic received on ports 80 through 88 is forwarded to the configured servers via the respective ports.

Port	?	Port Mapping	Service Port: 80	Map to Port: 88
------	---	--------------	------------------	-----------------

Port Mapping: traffic that is received by Pepwave router via the specified protocol at the specified port is forwarded via a different port to the servers specified by the **Servers** setting. For example, with **IP Protocol** set to **TCP**, and **Port** set to **Port Mapping**, **Service Port** 80, and **Map to Port** 88, TCP traffic on port 80 is forwarded to the configured servers via port 88. (Please see below for details on the **Servers** setting.)

Port	?	Range Mapping	Service Ports: 80 - 88	Map to Ports: 88 - 96
------	---	---------------	------------------------	-----------------------

Range Mapping: traffic that is received by the Pepwave router via the specified protocol at the specified port range is forwarded via a different port to the servers specified by the **Servers** setting.

Inbound IP Address(es) This setting specifies the WAN connections and Internet IP address(es) from which the service can be accessed.

Server IP Address This setting specifies the LAN IP address of the server that handles the requests for the service.

16.1.1 UPnP / NAT-PMP Settings

UPnP and NAT-PMP are network protocols which allow a computer connected to the LAN port to automatically configure the router to allow parties on the WAN port to connect to itself. That way, the process of inbound port forwarding becomes automated.

When a computer creates a rule using these protocols, the specified TCP/UDP port of all WAN connections' default IP address will be forwarded.

Check the corresponding box(es) to enable UPnP and/or NAT-PMP. Enable these features

only if you trust the computers connected to the LAN ports.

UPnP / NAT-PMP Settings	
UPnP	<input checked="" type="checkbox"/> Enable
NAT-PMP	<input checked="" type="checkbox"/> Enable
<input type="button" value="Save"/>	

When the options are enabled, a table listing all the forwarded ports under these two protocols can be found at **Status>UPnP / NAT-PMP**.

17 NAT Mappings

NAT mappings allow IP address mapping of all inbound and outbound NAT'd traffic to and from an internal client IP address. Settings to configure NAT mappings are located at **Advanced>NAT Mappings**.

LAN Clients	Inbound Mappings	Outbound Mappings	
192.168.1.23	(WAN 1):10.88.3.158 (Interface IP)	Use Interface IP only	<input type="button" value="X"/>
<input type="button" value="Add NAT Rule"/>			

To add a rule for NAT mappings, click **Add NAT Rule**.

LAN Client(s)	<input type="button" value="?"/> IP Address ▾														
Address	<input type="button" value="?"/> <input type="text"/>														
Inbound Mappings	<input type="button" value="?"/> <table border="1"> <thead> <tr> <th colspan="2">Connection / Inbound IP Address(es)</th> </tr> </thead> <tbody> <tr><td><input type="checkbox"/> WAN 1</td></tr> <tr><td><input type="checkbox"/> WAN 2</td></tr> <tr><td><input type="checkbox"/> Wi-Fi WAN</td></tr> <tr><td><input type="checkbox"/> Cellular 1</td></tr> <tr><td><input type="checkbox"/> Cellular 2</td></tr> <tr><td><input type="checkbox"/> USB</td></tr> </tbody> </table>	Connection / Inbound IP Address(es)		<input type="checkbox"/> WAN 1	<input type="checkbox"/> WAN 2	<input type="checkbox"/> Wi-Fi WAN	<input type="checkbox"/> Cellular 1	<input type="checkbox"/> Cellular 2	<input type="checkbox"/> USB						
Connection / Inbound IP Address(es)															
<input type="checkbox"/> WAN 1															
<input type="checkbox"/> WAN 2															
<input type="checkbox"/> Wi-Fi WAN															
<input type="checkbox"/> Cellular 1															
<input type="checkbox"/> Cellular 2															
<input type="checkbox"/> USB															
Outbound Mappings	<input type="button" value="?"/> <table border="1"> <thead> <tr> <th colspan="2">Connection / Outbound IP Address</th> </tr> </thead> <tbody> <tr><td>WAN 1</td><td>10.88.3.158 (Interface IP) ▾</td></tr> <tr><td>WAN 2</td><td>Interface IP ▾</td></tr> <tr><td>Wi-Fi WAN</td><td>Interface IP ▾</td></tr> <tr><td>Cellular 1</td><td>Interface IP ▾</td></tr> <tr><td>Cellular 2</td><td>Interface IP ▾</td></tr> <tr><td>USB</td><td>Interface IP ▾</td></tr> </tbody> </table>	Connection / Outbound IP Address		WAN 1	10.88.3.158 (Interface IP) ▾	WAN 2	Interface IP ▾	Wi-Fi WAN	Interface IP ▾	Cellular 1	Interface IP ▾	Cellular 2	Interface IP ▾	USB	Interface IP ▾
Connection / Outbound IP Address															
WAN 1	10.88.3.158 (Interface IP) ▾														
WAN 2	Interface IP ▾														
Wi-Fi WAN	Interface IP ▾														
Cellular 1	Interface IP ▾														
Cellular 2	Interface IP ▾														
USB	Interface IP ▾														

NAT Mapping Settings

LAN Client(s)	NAT mapping rules can be defined for a single LAN IP Address , an IP Range , or an IP Network .
Address	This refers to the LAN host's private IP address. The system maps this address to a number of public IP addresses (specified below) in order to facilitate inbound and outbound traffic. This option is only available when IP Address is selected.
Range	The IP range is a contiguous group of private IP addresses used by the LAN host. The system maps these addresses to a number of public IP addresses (specified below) to facilitate outbound traffic. This option is only available when IP Range is selected.
Network	The IP network refers to all private IP addresses and ranges managed by the LAN host. The system maps these addresses to a number of public IP addresses (specified below) to facilitate outbound traffic. This option is only available when IP Network is selected.
Inbound Mappings	<p>This setting specifies the WAN connections and corresponding WAN-specific Internet IP addresses on which the system should bind. Any access to the specified WAN connection(s) and IP address(es) will be forwarded to the LAN host. This option is only available when IP Address is selected in the LAN Client(s) field.</p> <p>Note that inbound mapping is not needed for WAN connections in drop-in mode or IP forwarding mode. Also note that each WAN IP address can be associated to one NAT mapping only.</p>
Outbound Mappings	<p>This setting specifies the WAN IP addresses that should be used when an IP connection is made from a LAN host to the Internet. Each LAN host in an IP range or IP network will be evenly mapped to one of each selected WAN's IP addresses (for better IP address utilization) in a persistent manner (for better application compatibility).</p> <p>Note that if you do not want to use a specific WAN for outgoing accesses, you should still choose default here, then customize the outbound access rule in the Outbound Policy section. Also note that WAN connections in drop-in mode or IP forwarding mode are not shown here.</p>

Click **Save** to save the settings when configuration has been completed.

Important Note

Inbound firewall rules override the **Inbound Mappings** settings.

18 QoS

18.1 User Groups

LAN and PPTP clients can be categorized into three user groups: **Manager, Staff, and Guest**. This menu allows you to define rules and assign client IP addresses or subnets to a user group.

You can apply different bandwidth and traffic prioritization policies on each user group in the **Bandwidth Control** and **Application** sections (note that the options available here vary by model).

The table is automatically sorted by rule precedence. The smaller and more specific subnets are put towards the top of the table and have higher precedence; larger and less specific subnets are placed towards the bottom.

Click the **Add** button to define clients and their user group. Click the  button to remove the defined rule. Two default rules are pre-defined and put at the bottom. They are **All DHCP reservation clients** and **Everyone**, and they cannot be removed. The **All DHCP reservation client represents** the LAN clients defined in the DHCP Reservation table on the LAN settings page. **Everyone** represents all clients that are not defined in any rule above. Click on a rule to change its group.

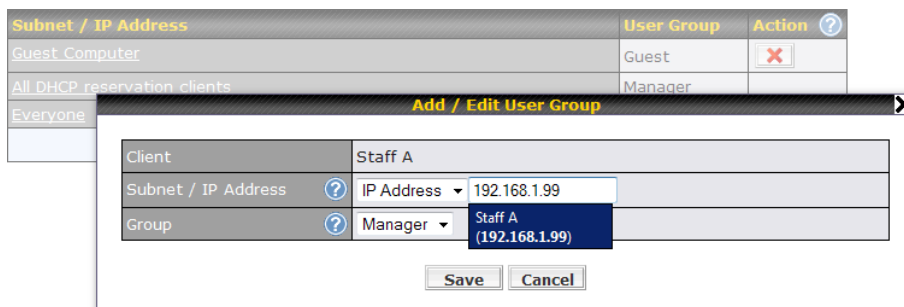

Add / Edit User Group	
Subnet / IP Address	From the drop-down menu, choose whether you are going to define the client(s) by an IP Address or a Subnet . If IP Address is selected, enter a name defined in DHCP reservation table or a LAN client's IP address. If Subnet is selected, enter a subnet address and specify its subnet mask.
Group	This field is to define which User Group the specified subnet / IP address belongs to.

Once users have been assigned to a user group, their internet traffic will be restricted by rules defined for that particular group. Please refer to the following two sections for details.

18.2 Bandwidth Control

You can define a maximum download speed (over all WAN connections) and upload speed

(for each WAN connection) that each individual Staff and Guest member can consume. No limit can be imposed on individual Manager members. By default, download and upload bandwidth limits are set to unlimited (set as 0).

Group Bandwidth Reservation			
Enable	<input checked="" type="checkbox"/>		
Bandwidth %	Manager	Staff	Guest
		50%	30%
WAN 1	500.0M/500.0M	300.0M/300.0M	200.0M/200.0M
WAN 2	500.0M/500.0M	300.0M/300.0M	200.0M/200.0M

18.3 Application

18.3.1 Application Prioritization

On many Pepwave routers, you can choose whether to apply the same prioritization settings to all user groups or customize the settings for each group.

Application Prioritization	
<input checked="" type="radio"/>	Apply same settings to all users
<input type="radio"/>	Customize

Three application priority levels can be set: **↑ High**, **— Normal**, and **↓ Low**. Pepwave routers can detect various application traffic types by inspecting the packet content. Select an application by choosing a supported application, or by defining a custom application manually. The priority preference of supported applications is placed at the top of the table. Custom applications are at the bottom.

Application	Priority			
	Manager	Staff	Guest	
All Supported Streaming Applications	↑ High	— Normal	↑ High	✘
All Email Protocols	↑ High	↑ High	↑ High	✘
MySQL	↑ High	— Normal	↓ Low	✘
SIP	↑ High	↓ Low	↓ Low	✘
<input type="button" value="Add"/>				

18.3.2 Prioritization for Custom Applications

Click the **Add** button to define a custom application. Click the button **✘** in the **Action** column to delete the custom application in the corresponding row.

When **Supported Applications** is selected, the Pepwave router will inspect network traffic and prioritize the selected applications. Alternatively, you can select **Custom Applications** and define the application by providing the protocol, scope, port number, and DSCP value.

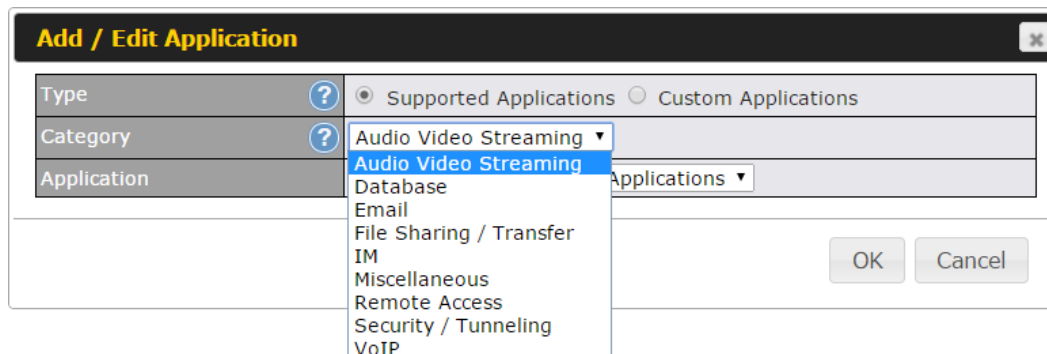

18.3.3 DSL/Cable Optimization

DSL/cable-based WAN connections have lower upload bandwidth and higher download bandwidth. When a DSL/cable circuit's uplink is congested, the download bandwidth will be affected. Users will not be able to download data at full speed until the uplink becomes less congested. **DSL/Cable Optimization** can relieve such an issue. When it is enabled, the download speed will become less affected by the upload traffic. By default, this feature is enabled.

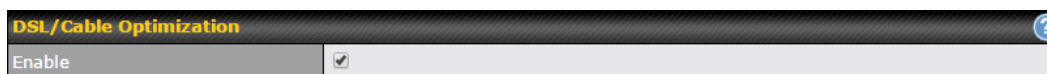

19 Firewall

A firewall is a mechanism that selectively filters data traffic between the WAN side (the Internet) and the LAN side of the network. It can protect the local network from potential hacker attacks, access to offensive websites, and/or other inappropriate uses.

The firewall functionality of Pepwave routers supports the selective filtering of data traffic in both directions:

- Outbound (LAN to WAN)
- Inbound (WAN to LAN)

The firewall also supports the following functionality:

- Intrusion detection and DoS prevention
- Web blocking

With SpeedFusion™ enabled, the firewall rules also apply to VPN tunneled traffic.

Outbound Firewall Rules (Drag and drop rows to change rule order)

Rule	Protocol	Source IP Port	Destination IP Port	Policy
Default	Any	Any	Any	Allow

Inbound Firewall Rules (Drag and drop rows to change rule order)

Rule	Protocol	WAN	Source IP Port	Destination IP Port	Policy
Default	Any	Any	Any	Any	Allow

Apply Firewall Rules to PepVPN Traffic

Enabled

Intrusion Detection and DoS Prevention

Disabled

19.1 Outbound and Inbound Firewall Rules

19.1.1 Access Rules

The outbound firewall settings are located at **Advanced>Firewall>Access Rules>Outbound Firewall Rules**.

Outbound Firewall Rules (Drag and drop rows to change rule order)

Rule	Protocol	Source IP Port	Destination IP Port	Policy
Default	Any	Any	Any	Allow

Click **Add Rule** to display the following screen:

Add a New Outbound Firewall Rule
✕

New Firewall Rule

Rule Name	<input type="text"/>
Enable	<input checked="" type="checkbox"/> Always on ▾
Protocol	Any ▾ ◀ :: Protocol Selection Tool :: ▾
Source IP & Port	Any Address ▾
Destination IP & Port	Any Address ▾
Action	<input checked="" type="radio"/> Allow <input type="radio"/> Deny
Event Logging	<input type="checkbox"/> Enable

Inbound firewall settings are located at **Advanced>Firewall>Access Rules>Inbound Firewall Rules**.

Inbound Firewall Rules (🖱️ Drag and drop rows to change rule order)
?

Rule	Protocol	WAN	Source IP Port	Destination IP Port	Policy
Default	Any	Any	Any	Any	Allow

Click **Add Rule** to display the following screen:

Add a New Inbound Firewall Rule
✕

New Firewall Rule

Rule Name	<input type="text"/>
Enable	<input checked="" type="checkbox"/>
WAN Connection	Any ▾
Protocol	Any ▾ ◀ :: Protocol Selection Tool :: ▾
Source IP & Port	Any Address ▾
Destination IP & Port	Any Address ▾
Action	<input checked="" type="radio"/> Allow <input type="radio"/> Deny
Event Logging	<input type="checkbox"/> Enable

Rules are matched from top to bottom. If a connection matches any one of the upper rules, the matching process will stop. If none of the rules match, the **Default** rule will be applied. By default, the **Default** rule is set as **Allow** for both outbound and inbound access.

Inbound / Outbound Firewall Settings	
Rule Name	This setting specifies a name for the firewall rule.
Enable	<p>This setting specifies whether the firewall rule should take effect. If the box is checked, the firewall rule takes effect. If the traffic matches the specified protocol/IP/port, actions will be taken by the Pepwave router based on the other parameters of the rule. If the box is not checked, the firewall rule does not take effect. The Pepwave router will disregard the other parameters of the rule.</p> <p>Click the dropdown menu next to the checkbox to place this firewall rule on a time schedule.</p>
WAN Connection (Inbound)	Select the WAN connection that this firewall rule should apply to.
Protocol	<p>This setting specifies the protocol to be matched. Via a drop-down menu, the following protocols can be specified:</p> <ul style="list-style-type: none"> • TCP • UDP • ICMP • IP <p>Alternatively, the Protocol Selection Tool drop-down menu can be used to automatically fill in the protocol and port number of common Internet services (e.g., HTTP, HTTPS, etc.) After selecting an item from the Protocol Selection Tool drop-down menu, the protocol and port number remains manually modifiable.</p>
Source IP & Port	<p>This specifies the source IP address(es) and port number(s) to be matched for the firewall rule. A single address, or a network, can be specified as the Source IP & Port setting, as indicated by the following screenshot:</p> <div style="border: 1px solid #ccc; padding: 5px; margin: 10px 0;"> <div style="display: flex; align-items: center;"> <div style="border-right: 1px solid #ccc; padding-right: 5px;">Source IP & Port</div> <div style="margin-left: 10px;"> ? </div> <div style="border: 1px solid #ccc; padding: 2px;"> <div style="display: flex; align-items: center;"> <div style="border-right: 1px solid #ccc; padding-right: 5px;">Single Address ▾ IP:</div> <input style="width: 150px;" type="text"/> </div> <div style="display: flex; align-items: center; margin-top: 2px;"> <div style="border-right: 1px solid #ccc; padding-right: 5px;">Single Port ▾ Port:</div> <input style="width: 50px;" type="text"/> </div> </div> </div> </div> <p>In addition, a single port, or a range of ports, can be specified for the Source IP & Port settings.</p>
Destination IP & Port	<p>This specifies the destination IP address(es) and port number(s) to be matched for the firewall rule. A single address, or a network, can be specified as the Destination IP & Port setting, as indicated by the following screenshot:</p> <div style="border: 1px solid #ccc; padding: 5px; margin: 10px 0;"> <div style="display: flex; align-items: center;"> <div style="border-right: 1px solid #ccc; padding-right: 5px;">Destination IP & Port</div> <div style="margin-left: 10px;"> ? </div> <div style="border: 1px solid #ccc; padding: 2px;"> <div style="display: flex; align-items: center;"> <div style="border-right: 1px solid #ccc; padding-right: 5px;">Single Address ▾ IP:</div> <input style="width: 150px;" type="text"/> </div> <div style="display: flex; align-items: center; margin-top: 2px;"> <div style="border-right: 1px solid #ccc; padding-right: 5px;">Single Port ▾ Port:</div> <input style="width: 50px;" type="text"/> </div> </div> </div> </div> <p>In addition, a single port, or a range of ports, can be specified for the Destination IP & Port settings.</p>
Action	<p>This setting specifies the action to be taken by the router upon encountering traffic that matches the both of the following:</p> <ul style="list-style-type: none"> • Source IP & port

- Destination IP & port

With the value of **Allow** for the **Action** setting, the matching traffic passes through the router (to be routed to the destination). If the value of the **Action** setting is set to **Deny**, the matching traffic does not pass through the router (and is discarded).

This setting specifies whether or not to log matched firewall events. The logged messages are shown on the page **Status>Event Log**. A sample message is as follows:

Aug 13 23:47:44 Denied CONN=Ethernet WAN SRC=20.3.2.1

DST=192.168.1.20 LEN=48 PROTO=TCP SPT=2260 DPT=80

Event Logging

- **CONN:** The connection where the log entry refers to
- **SRC:** Source IP address
- **DST:** Destination IP address
- **LEN:** Packet length
- **PROTO:** Protocol
- **SPT:** Source port
- **DPT:** Destination port

Click **Save** to store your changes. To create an additional firewall rule, click **Add Rule** and repeat the above steps.

To change a rule's priority, simply drag and drop the rule:

- Hold the left mouse button on the rule.
- Move it to the desired position.
- Drop it by releasing the mouse button.

Tip

If the default inbound rule is set to **Allow** for NAT-enabled WANs, no inbound Allow firewall rules will be required for inbound port forwarding and inbound NAT mapping rules. However, if the default inbound rule is set as **Deny**, a corresponding Allow firewall rule will be required.

19.1.2 Apply Firewall Rules to PepVpn Traffic

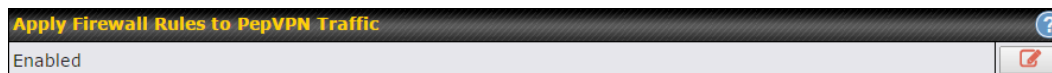

When this option is enabled, Outbound Firewall Rules will be applied to PepVPN traffic. To turn on this feature, click , check the **Enable** check box, and press the **Save** button.

19.1.3 Intrusion Detection and DoS Prevention

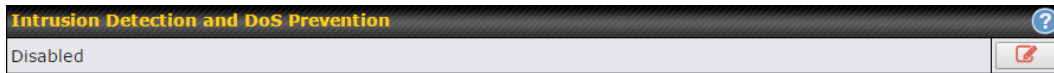

Pepwave routers can detect and prevent intrusions and denial-of-service (DoS) attacks from the Internet. To turn on this feature, click , check the **Enable** check box, and press the **Save** button.

When this feature is enabled, the Pepwave router will detect and prevent the following kinds of intrusions and denial-of-service attacks.

- Port scan
 - NMAP FIN/URG/PSH
 - Xmas tree
 - Another Xmas tree
 - Null scan
 - SYN/RST
 - SYN/FIN
- SYN flood prevention
- Ping flood attack prevention

19.2 Content Blocking

Application Blocking ?

Please Select Application... +

Web Blocking ?

Preset Category

<input type="radio"/> High	<input type="checkbox"/> Abortion	<input type="checkbox"/> Adware	<input type="checkbox"/> Aggressive
<input type="radio"/> Moderate	<input type="checkbox"/> Alcohol	<input type="checkbox"/> Anti-Spyware	<input type="checkbox"/> Chatroom
<input type="radio"/> Low	<input type="checkbox"/> Dating	<input type="checkbox"/> Drugs	<input type="checkbox"/> Ecommerce/Shopping
<input checked="" type="radio"/> Custom	<input type="checkbox"/> Entertainment	<input type="checkbox"/> File Hosting	<input type="checkbox"/> P2P/File sharing
	<input type="checkbox"/> Gambling	<input type="checkbox"/> Games	<input type="checkbox"/> Hacking
	<input type="checkbox"/> Instant Messaging	<input type="checkbox"/> Job Search/Employment	<input type="checkbox"/> Kids Time Wasting
	<input type="checkbox"/> Lingerie	<input type="checkbox"/> Malware	<input type="checkbox"/> Manga/Anime/Webcomic
	<input type="checkbox"/> Nudity	<input type="checkbox"/> News/Media	<input type="checkbox"/> Auctions
	<input type="checkbox"/> Phishing	<input type="checkbox"/> Pornography	<input type="checkbox"/> Proxy/Anonymizer
	<input type="checkbox"/> Radio	<input type="checkbox"/> Remote Access	<input type="checkbox"/> Ringtones
	<input type="checkbox"/> Search Engines	<input type="checkbox"/> Sexuality Education	<input type="checkbox"/> Social Networking
	<input type="checkbox"/> Sports	<input type="checkbox"/> Spyware	<input type="checkbox"/> Tobacco
	<input type="checkbox"/> Update Sites	<input type="checkbox"/> Vacation	<input type="checkbox"/> Violence
	<input type="checkbox"/> Viruses	<input type="checkbox"/> Weapons	<input type="checkbox"/> Weather
	<input type="checkbox"/> Webmail	<input type="checkbox"/> WebTV	

Customized Domains

cbs.com	✖
	+

Exempted Domains from Web Blocking

	+
--	---

Exempted User Groups ?

Manager	<input type="checkbox"/> Exempt
Staff	<input type="checkbox"/> Exempt
Guest	<input type="checkbox"/> Exempt

Exempted Subnets ?

Network	Subnet Mask	
	255.255.255.0 (/24)	+

URL Logging

Enable	<input type="checkbox"/>	
Log Server Host		Port: <input style="width: 40px; border: 1px solid #ccc;" type="text"/>

19.2.1 Application Blocking

Choose applications to be blocked from LAN/PPTP/PepVPN peer clients' access, except for those on the Exempted User Groups or Exempted Subnets defined below.

19.2.2 Web Blocking

Defines web site domain names to be blocked from LAN/PPTP/PepVPN peer clients' access except for those on the Exempted User Groups or Exempted Subnets defined below.

If "foobar.com" is entered, any web site with a host name ending in foobar.com will be blocked, e.g. www.foobar.com, foobar.com, etc. However, "myfoobar.com" will not be blocked.

You may enter the wild card ".*" at the end of a domain name to block any web site with a host name having the domain name in the middle. If you enter "foobar.*", then "www.foobar.com", "www.foobar.co.jp", or "foobar.co.uk" will be blocked. Placing the wild card in any other position is not supported.

The device will inspect and look for blocked domain names on all HTTP traffic. Secure web (HTTPS) traffic is not supported.

19.2.3 Customized Domains

Enter an appropriate website address, and the Peplink Balance will block and disallow LAN/PPTP/SpeedFusion™ peer clients to access these websites. Exceptions can be added using the instructions in Sections 20.1.3.2 and 20.1.3.3.

You may enter the wild card ".*" at the end of a domain name to block any web site with a host name having the domain name in the middle. For example, If you enter "foobar.*", then "www.foobar.com," "www.foobar.co.jp," or "foobar.co.uk" will be blocked. Placing the wild card in any other position is not supported.

The Peplink Balance will inspect and look for blocked domain names on all HTTP traffic. Secure web (HTTPS) traffic is not supported.

19.2.4 Exempted User Groups

Check and select pre-defined user group(s) who can be exempted from the access blocking rules. User groups can be defined at **QoS>User Groups** section. Please refer to **Section 17.1** for details.

19.2.5 Exempted Subnets

With the subnet defined in the field, clients on the particular subnet(s) can be exempted from the access blocking rules.

19.2.6 URL Logging

Click **enable**, and then enter the ip address and port (if applicable) where your remote syslog server is located.

20 OSPF & RIPv2

The Peplink Balance supports OSPF and RIPv2 dynamic routing protocols. Click the **Network** tab from the top bar, and then click the **OSPF & RIPv2** item on the sidebar to reach the following menu:

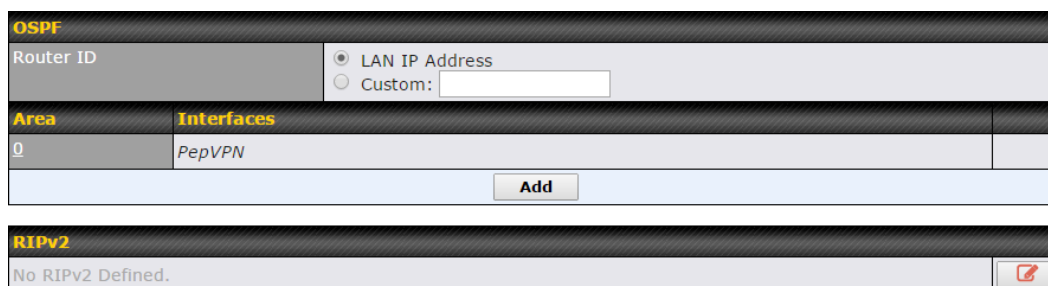

OSPF	
Router ID	This field determines the ID of the router. By default, this is specified as the LAN IP address. If you want to specify your own ID, enter it in the Custom field.
Area	This is an overview of the OSPFv2 areas you have defined. Click on the area name to configure it. To set a new area, click Add . To delete an existing area, click .

OSPF Settings
✕

Area ID	<input style="width: 90%;" type="text"/>
Link Type	<input checked="" type="radio"/> Broadcast <input type="radio"/> Point-to-Point
Authentication	MD5 ▾ <input style="width: 80%;" type="text"/>
Interfaces	<input type="checkbox"/> LAN (192.168.168.1/24) <input type="checkbox"/> V167 (192.168.167.1/24) <input type="checkbox"/> WAN 1 (10.91.137.1/24) <input type="checkbox"/> WAN 2 (10.91.138.1/24) <input type="checkbox"/> WAN 3 (10.91.139.1/24) <input type="checkbox"/> WAN 4 <input type="checkbox"/> WAN 5 <input type="checkbox"/> WAN 6 <input type="checkbox"/> WAN 7 <input type="checkbox"/> WAN 8 <input type="checkbox"/> WAN 9 <input type="checkbox"/> WAN 10 <input type="checkbox"/> WAN 11 <input type="checkbox"/> WAN 12

OSPF Settings	
Area ID	Determine the name of your Area ID to apply to this group. Machines linked to this group will send and receive related OSPF packets, while unlinked machines will ignore it.
Link Type	Choose the network type that this area will use.
Authentication	Choose an authentication method, if one is used, from this drop-down menu. Available options are MD5 and Text . Enter the authentication key next to the drop-down menu.
Interfaces	Determine which interfaces this area will use to listen to and deliver OSPF packets

To access RIPv2 settings, click .

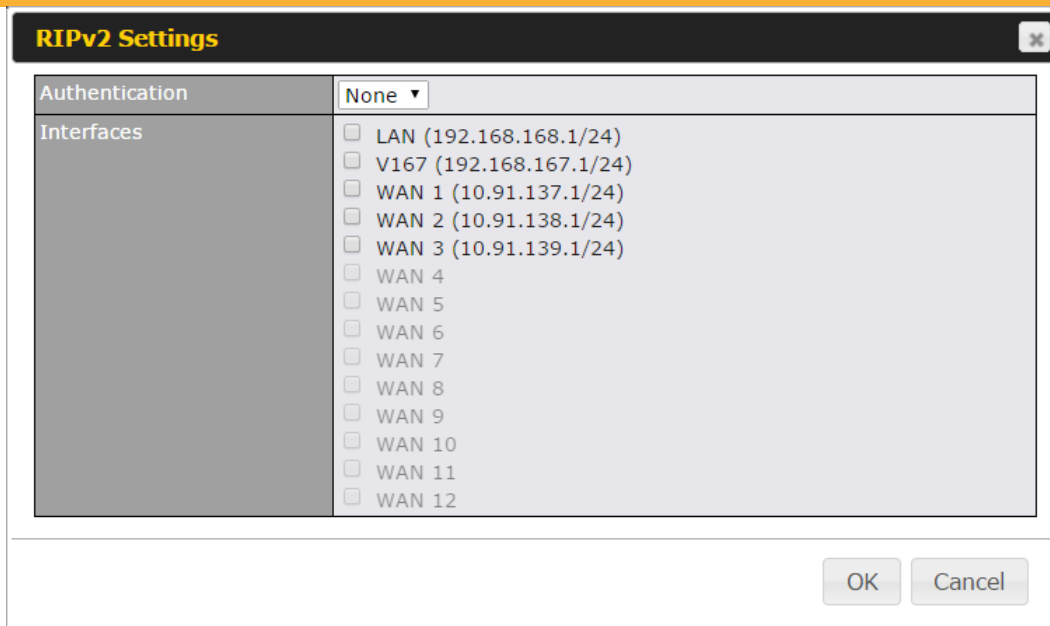

RIPv2 Settings	
Authentication	Choose an authentication method, if one is used, from this drop-down menu. Available options are MD5 and Text . Enter the authentication key next to the drop-down menu.
Interfaces	Determine which interfaces this group will use to listen to and deliver RIPv2 packets.

21 Remote User Access

a Networks routed by a Peplink Balance can be remotely accessed via L2TP with IPsec or PPTP. To configure this feature, navigate to **Network > Remote User Access**

Remote User Access Settings			
Enable	<input checked="" type="checkbox"/>		
VPN Type	<input checked="" type="radio"/> L2TP with IPsec <input type="radio"/> PPTP IPsec NAT-Traversal will be enabled to ensure compatibility for most of the devices		
Preshared Key	<input type="text"/> <input checked="" type="checkbox"/> Hide Characters		
Listen On	Connection / IP Address(es)		
	<input checked="" type="checkbox"/> WAN 1	<input checked="" type="checkbox"/> 10.10.11.107 (Interface IP)	
	<input checked="" type="checkbox"/> WAN 2	<input checked="" type="checkbox"/> Interface IP	
	<input checked="" type="checkbox"/> Wi-Fi WAN	<input checked="" type="checkbox"/> Interface IP	
	<input checked="" type="checkbox"/> Cellular 1	<input checked="" type="checkbox"/> Interface IP	
	<input checked="" type="checkbox"/> Cellular 2	<input checked="" type="checkbox"/> Interface IP	
	<input checked="" type="checkbox"/> USB	<input checked="" type="checkbox"/> Interface IP	
	Connect to Network	Untagged LAN ▾	
Authentication	Local User Accounts ▾		
User Accounts	Username	Password	
	admin	••••••••	<input checked="" type="checkbox"/>
	<input type="text"/>	<input type="text"/>	<input type="checkbox"/>

Remote User Access Settings	
Enable	Click the checkbox to enable Remote User Access.
VPN Type	Determine whether remote devices can connect to the Balance using L2TP with IPsec or

	PPTP. For greater security, we recommend you connect using L2TP with IPsec.
Preshared Key	Enter your preshared key in the text field. Please note that remote devices will need this preshared key to access the Balance.
Listen On	This setting is for specifying the WAN IP addresses where the PPTP server of the router should listen on.
Connect to Network	Select the VLAN network for remote users to enable remote user access on.
Authentication	Determine the method of authenticating remote users.
User Accounts	<p>This setting allows you to define the PPTP User Accounts. Click Add to input username and password to create an account. After adding the user accounts, you can click on a username to edit the account password. Click the button X to delete the account in its corresponding row.</p> <p>Click the  button to switch to enters user accounts by pasting the information in.CSV format.</p>

Miscellaneous Settings

The miscellaneous settings include configuration for high availability, PPTP server, service forwarding, and service passthrough.

21.1 High Availability

Many Pepwave routers support high availability (HA) configurations via an open standard virtual router redundancy protocol (VRRP, RFC 3768). In an HA configuration, two Pepwave routers provide redundancy and failover in a master-slave arrangement. In the event that the master unit is down, the slave unit becomes active. High availability will be disabled automatically where there is a drop-in connection configured on a LAN bypass port.

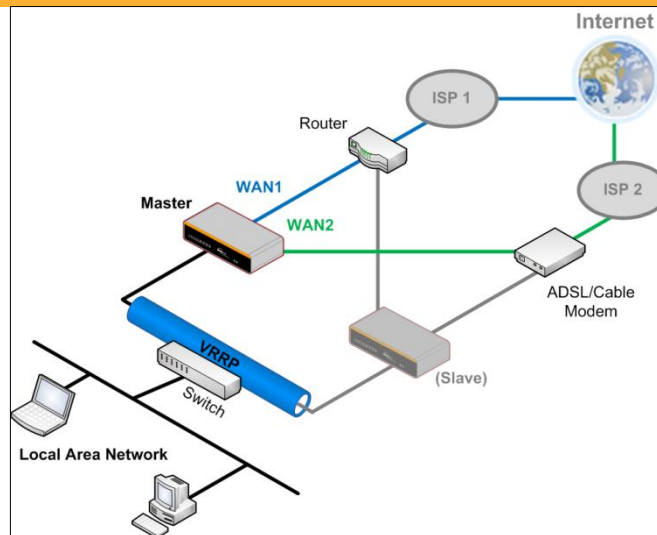

In the diagram, the WAN ports of each Pepwave router connect to the router and to the modem. Both Pepwave routers connect to the same LAN switch via a LAN port.

An elaboration on the technical details of the implementation of the virtual router redundancy protocol (VRRP, RFC 3768) by Pepwave routers follows:

- In an HA configuration, the two Pepwave routers communicate with each other using VRRP over the LAN.
- The two Pepwave routers broadcast heartbeat signals to the LAN at a frequency of one heartbeat signal per second.
- In the event that no heartbeat signal from the master Pepwave router is received in 3 seconds (or longer) since the last heartbeat signal, the slave Pepwave router becomes active.
- The slave Pepwave router initiates the WAN connections and binds to a previously configured LAN IP address.
- At a subsequent point when the master Pepwave router recovers, it will once again become active.

You can configure high availability at **Advanced>Misc. Settings>High Availability**.

Interface for Master Router

Interface for Slave Router

High Availability		High Availability	
Enable	<input checked="" type="checkbox"/>	Enable	<input checked="" type="checkbox"/>
Group Number	5	Group Number	5
Preferred Role	<input checked="" type="radio"/> Master <input type="radio"/> Slave	Preferred Role	<input type="radio"/> Master <input checked="" type="radio"/> Slave
Resume Master Role Upon Recovery	<input checked="" type="checkbox"/>	Configuration Sync.	<input type="checkbox"/> Master Serial Number: 54BF-5WEY-E37Q
Virtual IP		Virtual IP	
LAN Administration IP	192.168.1.1	LAN Administration IP	192.168.1.1
Subnet Mask	255.255.255.0	Subnet Mask	255.255.255.0

High Availability	
Enable	Checking this box specifies that the Pepwave router is part of a high availability configuration.
Group Number	This number identifies a pair of Pepwave routers operating in a high availability configuration. The two Pepwave routers in the pair must have the same Group Number value.
Preferred Role	This setting specifies whether the Pepwave router operates in master or slave mode. Click the corresponding radio button to set the role of the unit. One of the units in the pair must be configured as the master, and the other unit must be configured as the slave.
Resume Master Role Upon Recovery	This option is displayed when Master mode is selected in Preferred Role . If this option is enabled, once the device has recovered from an outage, it will take over and resume its Master role from the slave unit.
Configuration Sync.	This option is displayed when Slave mode is selected in Preferred Role . If this option is enabled and the Master Serial Number entered matches with the actual master unit's, the master unit will automatically transfer the configuration to this unit. Please make sure the LAN IP Address and the Subnet Mask fields are set correctly in the LAN settings page. You can refer to the Event Log for the configuration synchronization status.
Master Serial Number	If Configuration Sync. is checked, the serial number of the master unit is required here for the feature to work properly.
Virtual IP	The HA pair must share the same Virtual IP . The Virtual IP and the LAN Administration IP must be under the same network.
LAN Administration IP	This setting specifies a LAN IP address to be used for accessing administration functionality. This address should be unique within the LAN.
Subnet Mask	This setting specifies the subnet mask of the LAN.

Important Note

For Pepwave routers in NAT mode, the virtual IP (VIP) should be set as the default gateway for all hosts on the LAN segment. For example, a firewall sitting behind the Pepwave router should set its default gateway as the virtual IP instead of the IP of the master router.

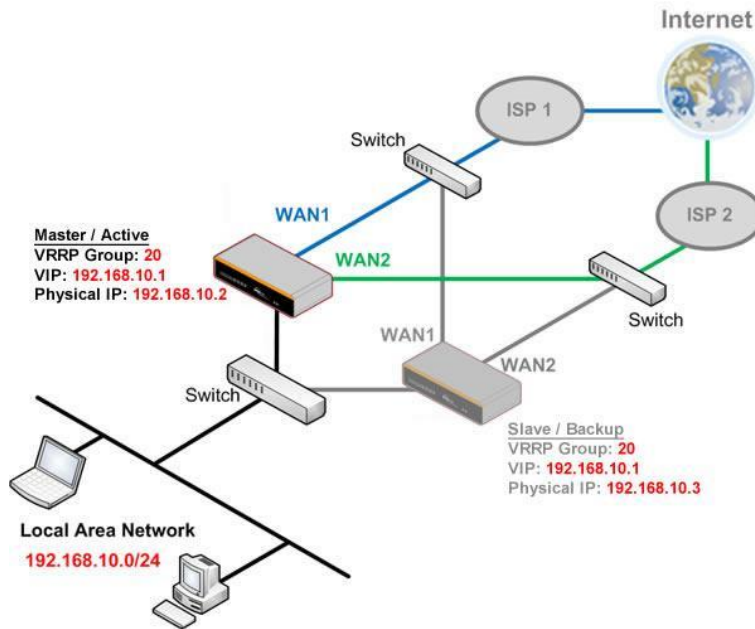

In drop-in mode, no other configuration needs to be set.

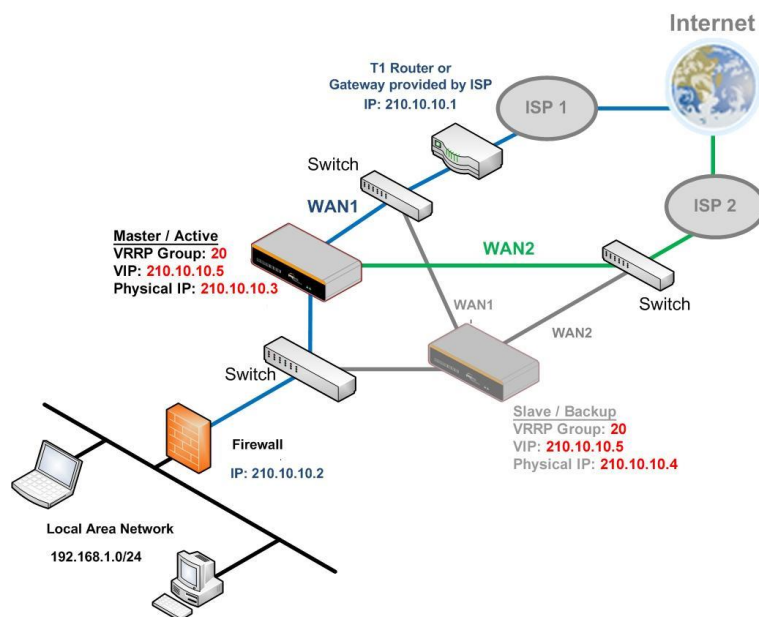

Please note that the drop-in WAN cannot be configured as a LAN bypass port while it is configured for high availability.

21.2 PPTP Server

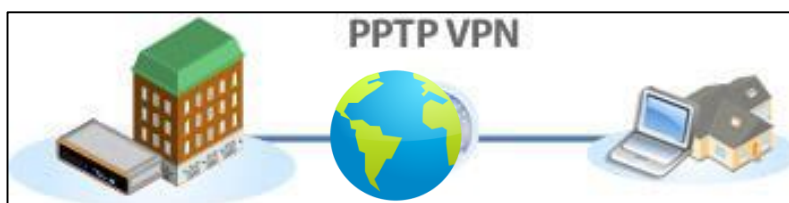

Pepwave routers feature a built-in PPTP server, which enables remote computers to conveniently and securely access the local network. PPTP server settings are located at **Advanced>Misc. Settings>PPTP Server**.

Check the box to enable PPTP server functionality. All connected PPTP sessions are displayed at **Status>Client List**. Please refer to **Section 22.3** for details. Note that available options vary by model.

PPTP Server		
Enable	<input checked="" type="checkbox"/>	
Listen On	Connection / IP Address(es)	
	<input checked="" type="checkbox"/> WAN 1	<input checked="" type="checkbox"/> 10.88.3.158 (Interface IP)
	<input checked="" type="checkbox"/> WAN 2	<input checked="" type="checkbox"/> Interface IP
	<input checked="" type="checkbox"/> Wi-Fi WAN	<input checked="" type="checkbox"/> Interface IP
	<input checked="" type="checkbox"/> Cellular 1	<input checked="" type="checkbox"/> Interface IP
	<input checked="" type="checkbox"/> Cellular 2	<input checked="" type="checkbox"/> Interface IP
	<input checked="" type="checkbox"/> USB	<input checked="" type="checkbox"/> Interface IP
Authentication	Local User Accounts ▼	
User Accounts	Username	Password



PPTP Server Settings	
Listen On	This setting is for specifying the WAN connection(s) and IP address(es) that the PPTP server should listen on.
Authentication	<p>This setting is for specifying the user database source for PPTP authentication. Three sources can be selected: Local User Accounts, LDAP Server, or RADIUS Server.</p> <p>Local User Accounts - User accounts are stored in the Pepwave router locally. You can add/modify/delete accounts in the User Accounts table.</p> <p>LDAP Server - Authenticate with an external LDAP server. This has been tested with Open LDAP servers where passwords are NTLM hashed. Active Directory is not supported. (You can choose to use RADIUS to authenticate with a Windows server.)</p> <p>RADIUS Server - Authenticate with an external RADIUS server. This has been tested with Microsoft Windows Internet Authentication Service and FreeRADIUS servers where</p>

passwords are NTLM hashed or in plain text.

User Accounts

This setting allows you to define PPTP user accounts for authentication via local user accounts. Click **Add** to input username and password to create an account. After adding the user accounts, you can click on a username to edit the account password. Click  to delete the account in its corresponding row.



21.3 Certificate Manager

Certificate Manager		
VPN Certificate	 No Certificate	Assign
Web Admin SSL Certificate	 No Certificate	Assign
Captive Portal SSL Certificate	No Certificate	Assign

This section allows you to assign certificates for local VPN and web admin SSL. The local keys will not be transferred to another device by any means.

21.4 Service Forwarding

Service forwarding settings are located at **Advanced>Misc. Settings>Service Forwarding**.

SMTP Forwarding Setup 	
SMTP Forwarding	<input type="checkbox"/> Enable
Web Proxy Forwarding Setup 	
Web Proxy Forwarding	<input type="checkbox"/> Enable
DNS Forwarding Setup 	
Forward Outgoing DNS Requests to Local DNS Proxy	<input type="checkbox"/> Enable
Custom Service Forwarding Setup	
Custom Service Forwarding	<input type="checkbox"/> Enable

Service Forwarding	
SMTP Forwarding	When this option is enabled, all outgoing SMTP connections destined for any host at TCP port 25 will be intercepted. These connections will be redirected to a specified SMTP server and port number. SMTP server settings for each WAN can be specified after selecting Enable .
Web Proxy Forwarding	When this option is enabled, all outgoing connections destined for the proxy server specified in Web Proxy Interception Settings will be intercepted. These connections will be redirected to a specified web proxy server and port number. Web proxy interception settings and proxy server settings for each WAN can be specified after selecting Enable .

DNS Forwarding

When this option is enabled, all outgoing DNS lookups will be intercepted and redirected to the built-in DNS name server. If any LAN device is using the DNS name servers of a WAN connection, you may want to enable this option to enhance the DNS availability without modifying the DNS server setting of the clients. The built-in DNS name server will distribute DNS lookups to corresponding DNS servers of all available WAN connections. In this case, DNS service will not be interrupted, even if any WAN connection is down.

Custom Service Forwarding

When custom service forwarding is enabled, outgoing traffic with the specified TCP port will be forwarded to a local or remote server by defining its IP address and port number.

21.4.1 SMTP Forwarding

Some ISPs require their users to send e-mails via the ISP's SMTP server. All outgoing SMTP connections are blocked except those connecting to the ISP's. Pepwave routers support intercepting and redirecting all outgoing SMTP connections (destined for TCP port 25) via a WAN connection to the WAN's corresponding SMTP server.

SMTP Forwarding Setup			
SMTP Forwarding		<input checked="" type="checkbox"/> Enable	
Connection	Enable Forwarding?	SMTP Server	SMTP Port
WAN 1	<input type="checkbox"/>	<input type="text"/>	<input type="text"/>
WAN 2	<input type="checkbox"/>	<input type="text"/>	<input type="text"/>
Wi-Fi WAN	<input type="checkbox"/>	<input type="text"/>	<input type="text"/>
Cellular 1	<input type="checkbox"/>	<input type="text"/>	<input type="text"/>
Cellular 2	<input type="checkbox"/>	<input type="text"/>	<input type="text"/>
USB	<input type="checkbox"/>	<input type="text"/>	<input type="text"/>

To enable the feature, select **Enable** under **SMTP Forwarding Setup**. Check **Enable Forwarding** for the WAN connection(s) that needs forwarding. Under **SMTP Server**, enter the ISP's e-mail server host name or IP address. Under **SMTP Port**, enter the TCP port number for each WAN.

The Pepwave router will intercept SMTP connections. Choose a WAN port according to the outbound policy, and then forward the connection to the SMTP server if the chosen WAN has enabled forwarding. If the forwarding is disabled for a WAN connection, SMTP connections for the WAN will be simply be forwarded to the connection's original destination.

Note

If you want to route all SMTP connections only to particular WAN connection(s), you should create a custom rule in outbound policy (see **Section 14.2**).

21.4.2 Web Proxy Forwarding

Web Proxy Forwarding Setup		
Web Proxy Forwarding	<input checked="" type="checkbox"/> Enable	
Web Proxy Interception Settings		
Proxy Server	IP Address <input type="text"/>	Port <input type="text"/>
<small>(Current settings in users' browser)</small>		
Connection	Enable Forwarding?	Proxy Server IP Address : Port
WAN 1	<input type="checkbox"/>	<input type="text"/> : <input type="text"/>
WAN 2	<input type="checkbox"/>	<input type="text"/> : <input type="text"/>
Wi-Fi WAN	<input type="checkbox"/>	<input type="text"/> : <input type="text"/>
Cellular 1	<input type="checkbox"/>	<input type="text"/> : <input type="text"/>
Cellular 2	<input type="checkbox"/>	<input type="text"/> : <input type="text"/>
USB	<input type="checkbox"/>	<input type="text"/> : <input type="text"/>

When this feature is enabled, the Pepwave router will intercept all outgoing connections destined for the proxy server specified in **Web Proxy Interception Settings**, choose a WAN connection with reference to the outbound policy, and then forward them to the specified web proxy server and port number. Redirected server settings for each WAN can be set here. If forwarding is disabled for a WAN, web proxy connections for the WAN will be simply forwarded to the connection's original destination.

21.4.3 DNS Forwarding

DNS Forwarding Setup	
Forward Outgoing DNS Requests to Local DNS Proxy	<input type="checkbox"/> Enable

When DNS forwarding is enabled, all clients' outgoing DNS requests will also be intercepted and forwarded to the built-in DNS proxy server.

21.4.4 Custom Service Forwarding

Custom Service Forwarding Setup			
Custom Service Forwarding	<input checked="" type="checkbox"/> Enable		
Settings	TCP Port	Server IP Address	Server Port
	<input type="text"/>	<input type="text"/>	<input type="text"/>
			<input type="button" value="+"/>

After clicking the **enable** checkbox, enter your TCP port for traffic heading to the router, and then specify the IP Address and Port of the server you wish to forward to the service to.

21.5 Service Passthrough

Service passthrough settings can be found at **Advanced>Misc. Settings>Service Passthrough**.

Service Passthrough Support	
SIP	<input checked="" type="radio"/> Standard Mode <input type="radio"/> Compatibility Mode <input checked="" type="checkbox"/> Define custom signal ports 1. <input type="text"/> 2. <input type="text"/> 3. <input type="text"/>
H.323	<input checked="" type="checkbox"/> Enable
FTP	<input checked="" type="checkbox"/> Enable <input checked="" type="checkbox"/> Define custom control ports 1. <input type="text"/> 2. <input type="text"/> 3. <input type="text"/>
TFTP	<input checked="" type="checkbox"/> Enable
IPsec NAT-T	<input checked="" type="checkbox"/> Enable <input checked="" type="checkbox"/> Define custom ports 1. <input type="text"/> 2. <input type="text"/> 3. <input type="text"/> <input checked="" type="checkbox"/> Route IPsec Site-to-Site VPN via WAN 1

(Registered trademarks are copyrighted by their respective owner)

Some Internet services need to be specially handled in a multi-WAN environment. Pepwave routers can handle these services such that Internet applications do not notice being behind a multi-WAN router. Settings for service passthrough support are available here.

Service Passthrough Support	
SIP	Session initiation protocol, aka SIP, is a voice-over-IP protocol. The Pepwave router can act as a SIP application layer gateway (ALG) which binds connections for the same SIP session to the same WAN connection and translate IP address in the SIP packets correctly in NAT mode. Such passthrough support is always enabled, and there are two modes for selection: Standard Mode and Compatibility Mode . If your SIP server's signal port number is non-standard, you can check the box Define custom signal ports and input the port numbers to the text boxes.
H.323	With this option enabled, protocols that provide audio-visual communication sessions will be defined on any packet network and pass through the Pepwave router.
FTP	FTP sessions consist of two TCP connections; one for control and one for data. In a multi-WAN situation, they must be routed to the same WAN connection. Otherwise, problems will arise in transferring files. By default, the Pepwave router monitors TCP control connections on port 21 for any FTP connections and binds TCP connections of the same FTP session to the same WAN. If you have an FTP server listening on a port number other than 21, you can check Define custom control ports and enter the port numbers in the text boxes.
TFTP	The Pepwave router monitors outgoing TFTP connections and routes any incoming TFTP data packets back to the client. Select Enable if you want to enable TFTP passthrough support.

IPsec NAT-T

This field is for enabling the support of IPsec NAT-T passthrough. UDP ports 500, 4500, and 10000 are monitored by default. You may add more custom data ports that your IPsec system uses by checking **Define custom ports**. If the VPN contains IPsec site-to-site VPN traffic, check **Route IPsec Site-to-Site VPN** and choose the WAN connection to route the traffic to.

21.6 GPS Forwarding

Using the GPS forwarding feature, some Pepwave routers can automatically send GPS reports to a specified server. To set up GPS forwarding, navigate to **Advanced>GPS Forwarding**.

GPS Forwarding				
Enable	<input checked="" type="checkbox"/>			
Server	Server IP Address / Host Name	Port	Protocol	Report Interval (s)
			UDP	1
GPS Report Format	<input checked="" type="radio"/> NMEA <input type="radio"/> TAIP			
NMEA Sentence Type	<input checked="" type="checkbox"/> GPRMC <input type="checkbox"/> GPGGA <input type="checkbox"/> GPVTG <input type="checkbox"/> GPGSA <input type="checkbox"/> GPGSV			
Vehicle ID (optional)	<input type="text"/>			

GPS Forwarding	
Enable	Check this box to turn on GPS forwarding.
Server	Enter the name/IP address of the server that will receive GPS data. Also specify a port number, protocol (UDP or TCP), and a report interval of between 1 and 10 seconds. Click <input type="button" value="+"/> to save these settings.
GPS Report Format	Choose from NMEA or TAIP format for sending GPS reports.
NMEA Sentence Type	If you've chosen to send GPS reports in NMEA format, select one or more sentence types for sending the data (GPRMC , GPGGA , GPVTG , GPGSA , and GPGSV).
Vehicle ID	The vehicle ID will be appended in the last field of the NMEA sentence. Note that the NMEA sentence will become customized and non-standard.

TAIP Sentence Type/TAIP ID (optional)

If you've chosen to send GPS reports in TAIP format, select one or more sentence types for sending the data (**PV—Position / Velocity Solution** and **CP—Compact Velocity Solution**). You can also optionally include an ID number in the **TAIP ID** field.

22 AP Controller

The AP controller acts as a centralized controller of Pepwave AP devices. With this feature, users can customize and manage multiple APs from a single Pepwave router interface.

Special Note

Each Pepwave router can control a limited number of routers without additional cost. To manage more, a Full Edition license is required. Please contact your Authorized Reseller or the Peplink Sales Team for more information and pricing details.

To configure, navigate to the **AP** tab.

22.1 Wireless SSID

This menu is the first one that appears after clicking the **AP** tab. This screen can also be reached by clicking **AP>Wireless SSID**. Note the appearance of this screen varies by model.

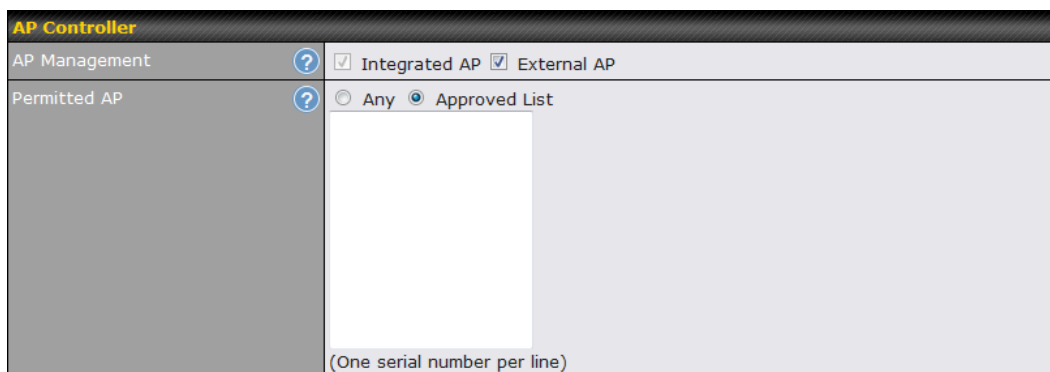

AP Controller

AP Management

The AP controller for managing Pepwave APs can be enabled by checking this box. When this option is enabled, the AP controller will wait for management connections originating from APs over the LAN on TCP and UDP port 11753. It will also wait for captive portal connections on TCP port 443. An extended DHCP option, **CAPWAP Access Controller addresses** (field

138), will be added to the DHCP server. A local DNS record, **AP Controller**, will be added to the local DNS proxy.

SSID	Security Policy	
PEPWAVE_8D1C	WPA/WPA2 - Personal	
New SSID		

Permitted AP

Access points to manage can be specified here. If **Any** is selected, the AP controller will manage any AP that reports to it. If **Approved List** is selected, only APs with serial numbers listed in the provided text box will be managed.

Current SSID information appears in the **SSID** section. To edit an existing SSID, click its name in the list. To add a new SSID, click **Add**. Note that the following settings vary by model.

SSID
✕

SSID Settings
?

SSID	<input style="width: 90%;" type="text"/>
Enable	<input type="text" value="Always on"/>
VLAN ID	<input type="text" value="Untagged LAN"/>
Broadcast SSID	<input checked="" type="checkbox"/>
Data Rate	<input checked="" type="radio"/> Auto <input type="radio"/> Fixed
Multicast Filter	<input type="checkbox"/>
Multicast Rate	<input type="text" value="MCS0/6M"/>
IGMP Snooping	<input type="checkbox"/>
Layer 2 Isolation	<input type="checkbox"/>
Maximum number of clients	2.4 GHz: <input type="text" value="0"/> 5 GHz: <input type="text" value="0"/> (0: Unlimited)
Band Steering	<input type="text" value="Disable"/>

Security Settings

Security Policy	<input type="text" value="Open (No Encryption)"/>
-----------------	---

Access Control Settings

Restricted Mode	<input type="text" value="None"/>
-----------------	-----------------------------------

SSID Settings	
SSID	This setting specifies the SSID of the virtual AP to be scanned by Wi-Fi clients.
Enable	Click the drop-down menu to apply a time schedule to this interface
VLAN ID	This setting specifies the VLAN ID to be tagged on all outgoing packets generated from this wireless network (i.e., packets that travel from the Wi-Fi segment through the Pepwave AP One unit to the Ethernet segment via the LAN port). The default value of this setting is 0 , which means VLAN tagging is disabled (instead of tagged with zero).
Broadcast SSID	This setting specifies whether or not Wi-Fi clients can scan the SSID of this wireless network. Broadcast SSID is enabled by default.
Data Rate ^A	Select Auto to allow the Pepwave router to set the data rate automatically, or select Fixed and choose a rate from the displayed drop-down menu.

Multicast Filter^A	This setting enables the filtering of multicast network traffic to the wireless SSID.
Multicast Rate^A	This setting specifies the transmit rate to be used for sending multicast network traffic. The selected Protocol and Channel Bonding settings will affect the rate options and values available here.
IGMP Snooping^A	To allow the Pepwave router to listen to internet group management protocol (IGMP) network traffic, select this option.
DHCP Option 82^A	If you use a distributed DHCP server/relay environment, you can enable this option to provide additional information on the manner in which clients are physically connected to the network.
Network Priority (QoS)^A	Select from Gold , Silver , and Bronze to control the QoS priority of this wireless network's traffic.
Layer 2 Isolation^A	Layer 2 refers to the second layer in the ISO Open System Interconnect model. When this option is enabled, clients on the same VLAN, SSID, or subnet are isolated to that VLAN, SSID, or subnet, which can enhance security. Traffic is passed to upper communication layer(s). By default, the setting is disabled.
Maximum Number of Clients	Indicate the maximum number of clients that should be able to connect to each frequency.
Band Steering^A	Band steering allows the Pepwave router to steer AP clients from the 2.4GHz band to the 5GHz band for better usage of bandwidth. To make steering mandatory, select Enforce . To cause the Pepwave router to preferentially choose steering, select Prefer . The default for this setting is Disable .

^A - Advanced feature. Click the  button on the top right-hand corner to activate.

Security Settings	
Security Policy	WPA2 - Personal ▼
Encryption	AES:CCMP
Shared Key 	<input type="password" value="••••••"/> <input checked="" type="checkbox"/> Hide Characters

Security Settings	
Security Policy	This setting configures the wireless authentication and encryption methods. Available options are Open (No Encryption) , WPA/WPA2 - Personal , WPA/WPA2 - Enterprise and Static WEP .

Access Control	
Restricted Mode	Deny all except listed ▾
MAC Address List	<input type="text"/>

Access Control

The settings allow administrator to control access using MAC address filtering. Available options are **None**, **Deny all except listed**, **Accept all except listed**, and **RADIUS MAC Authentication**.

Restricted Mode

When **WPA/WPA2 - Enterprise** is configured, RADIUS-based 802.1 x authentication is enabled. Under this configuration, the **Shared Key** option should be disabled. When using this method, select the appropriate version using the **V1/V2** controls. The security level of this method is known to be very high.

When **WPA/WPA2- Personal** is configured, a shared key is used for data encryption and authentication. When using this configuration, the **Shared Key** option should be enabled. Key length must be between eight and 63 characters (inclusive). The security level of this method is known to be high.

The configuration of **Static WEP** parameters enables pre-shared WEP key encryption. Authentication is not supported by this method. The security level of this method is known to be weak.

MAC Address List

Connection coming from the MAC addresses in this list will be either denied or accepted based the option selected in the previous field.

RADIUS Server Settings	Primary Server	Secondary Server
Host	<input type="text"/>	<input type="text"/>
Secret	<input type="text"/>	<input type="text"/>
Authentication Port	1812 <input type="button" value="Default"/>	1812 <input type="button" value="Default"/>
Accounting Port	1813 <input type="button" value="Default"/>	1813 <input type="button" value="Default"/>

RADIUS Server Settings

Host Enter the IP address of the primary RADIUS server and, if applicable, the secondary RADIUS server.

Secret Enter the RADIUS shared secret for the primary server and, if applicable, the secondary RADIUS server.

Authentication In field, enter the UDP authentication port(s) used by your RADIUS server(s) or click the

Port	Default button to enter 1812 .
Accounting Port	In field, enter the UDP accounting port(s) used by your RADIUS server(s) or click the Default button to enter 1813 .

22.2 Settings

On many Pepwave models, the AP settings screen (**AP>Settings**) looks similar to the example below:

AP Settings	
SSID	<input checked="" type="checkbox"/> 2.4 GHz <input checked="" type="checkbox"/> 5 GHz <input type="checkbox"/> Integrated AP supports 2.4 GHz only. Testing
Operating Country	United States
Preferred Frequency	<input checked="" type="radio"/> 2.4 GHz <input type="radio"/> 5 GHz Integrated AP supports 2.4 GHz only.
	<div style="display: flex; justify-content: space-between;"> <div>2.4 GHz</div> <div>5 GHz</div> </div>
Protocol	<div style="display: flex; justify-content: space-between;"> <div>802.11ng</div> <div>802.11n/ac</div> </div>
Channel Width	<div style="display: flex; justify-content: space-between;"> <div>20 MHz</div> <div>Auto</div> </div>
Channel	<div style="display: flex; justify-content: space-between;"> <div> Auto <input type="button" value="Edit"/> Channels: 1 2 3 4 5 6 7 8 9 10 11 </div> <div> Auto <input type="button" value="Edit"/> Channels: 36 40 44 48 52 56 60 64 100 104 108 112 116 120 124 128 132 136 140 149 153 157 161 165 </div> </div>
Auto Channel Update	<div style="display: flex; justify-content: space-between;"> <div> Daily at 03:00 <input checked="" type="checkbox"/> Wait until no active client associated </div> <div> Daily at 03:00 <input checked="" type="checkbox"/> Wait until no active client associated </div> </div>
Output Power	<div style="display: flex; justify-content: space-between;"> <div>Fixed: Max <input type="checkbox"/> Boost</div> <div>Fixed: Max <input type="checkbox"/> Boost</div> </div>
Client Signal Strength Threshold	<div style="display: flex; justify-content: space-between;"> <div>0 -95 dBm (0: Unlimited)</div> <div>0 -95 dBm (0: Unlimited)</div> </div>
Maximum number of clients	<div style="display: flex; justify-content: space-between;"> <div>0 (0: Unlimited)</div> <div>0 (0: Unlimited)</div> </div>
Management VLAN ID	Untagged LAN (No VLAN)
Operating Schedule	Always on
Beacon Rate	1 Mbps (6 Mbps will be used for 5 GHz radio)
Beacon Interval	100 ms
DTIM	1 Default
RTS Threshold	0 Default
Fragmentation Threshold	0 (0: Disable) Default
Distance / Time Converter	4050 m Note: Input distance for recommended values
Slot Time	<input type="radio"/> Auto <input checked="" type="radio"/> Custom 9 μs Default
ACK Timeout	48 μs Default
Frame Aggregation	<input type="checkbox"/>

AP Settings	
SSID	These buttons specify which wireless networks will use this AP profile. You can also select the frequencies at which each network will transmit. Please note that the Peplink Balance does not detect whether the AP is capable of transmitting at both frequencies. Instructions to transmit at unsupported frequencies will be ignored by the AP.
Operating	This drop-down menu specifies the national / regional regulations which the AP should follow.

Country	<ul style="list-style-type: none"> • If a North American region is selected, RF channels 1 to 11 will be available and the maximum transmission power will be 26 dBm (400 mW). • If European region is selected, RF channels 1 to 13 will be available. The maximum transmission power will be 20 dBm (100 mW). <p>NOTE: Users are required to choose an option suitable to local laws and regulations. Per FCC regulation, the country selection is not available on all models marketed in US. All US models are fixed to US channels only.</p>
Preferred Frequency	These buttons determine the frequency at which access points will attempt to broadcast. This feature will only work for APs that can transmit at both 5.4GHz and 5GHz frequencies.
Protocol	This section displays the 2.4 GHz protocols your APs are using.
Channel Width	There are three options: 20 MHz, 20/40 MHz, and 40 MHz. With this feature enabled, the Wi-Fi system can use two channels at once. Using two channels improves the performance of the Wi-Fi connection.
Channel	This drop-down menu selects the 802.11 channel to be utilized. Available options are from 1 to 11 and from 1 to 13 for the North America region and Europe region, respectively. (Channel 14 is only available when the country is selected as Japan with protocol 802.11b.) If Auto is set, the system will perform channel scanning based on the scheduled time set and choose the most suitable channel automatically.
Auto Channel Update	Indicate the time of day at which update automatic channel selection.
Output Power^A	<p>This drop-down menu determines the power at which the AP under this profile will broadcast. When fixed settings are selected, the AP will broadcast at the specified power level, regardless of context. When Dynamic settings are selected, the AP will adjust its power level based on its surrounding APs in order to maximize performance.</p> <p>The Dynamic: Auto setting will set the AP to do this automatically. Otherwise, the Dynamic: Manual setting will set the AP to dynamically adjust only of instructed to do so. If you have set Dynamic:Manual, you can go to AP>Toolbox>Auto Power Adj. to give your AP further instructions.</p> <p>If you click the Boost checkbox, the AP under this profile will transmit using additional power. Please note that using this option with several APs in close proximity will lead to increased interference.</p>
Client Signal Strength Threshold^A	This field determines that maximum signal strength each individual client will receive. The measurement unit is megawatts.
Max number of Clients^A	This field determines the maximum clients that can be connected to APs under this profile.
Management	This field specifies the VLAN ID to tag to management traffic, such as AP to AP

VLAN ID	controller communication traffic. The value is 0 by default, meaning that no VLAN tagging will be applied. NOTE: change this value with caution as alterations may result in loss of connection to the AP controller.
Operating Schedule	Choose from the schedules that you have defined in System>Schedule . Select the schedule for the integrated AP to follow from the drop-down menu.
Beacon Rate^A	This drop-down menu provides the option to send beacons in different transmit bit rates. The bit rates are 1Mbps, 2Mbps, 5.5Mbps, 6Mbps, and 11Mbps .
Beacon Interval^A	This drop-down menu provides the option to set the time between each beacon send. Available options are 100ms, 250ms, and 500ms .
DTIM^A	This field provides the option to set the frequency for beacon to include delivery traffic indication messages (DTIM). The interval unit is measured in milliseconds.
RTS Threshold^A	This field provides the option to set the minimum packet size for the unit to send an RTS using the RTS/CTS handshake. Setting 0 disables this feature.
Fragmentation Threshold^A	Determines the maximum size (in bytes) that each packet fragment will be broken down into. Set 0 to disable fragmentation.
Distance/Time Converter^A	Select the distance you want your Wi-Fi to cover in order to adjust the below parameters. Default values are recommended.
Slot Time^A	This field provides the option to modify the unit wait time before it transmits. The default value is 9µs .
ACK Timeout^A	This field provides the option to set the wait time to receive acknowledgement packet before doing retransmission. The default value is 48µs .
Frame Aggregation^A	With this feature enabled, throughput will be increased by sending two or more data frames in a single transmission.
Frame Length	This field is only available when Frame Aggregation is enabled. It specifies the frame length for frame aggregation. By default, it is set to 50000 .

^A - Advanced feature. Click the button on the top right-hand corner to activate.







Web Administration Settings (on External AP)	
Enable	<input checked="" type="checkbox"/>
Web Access Protocol	<input type="radio"/> HTTP <input checked="" type="radio"/> HTTPS
Management Port	<input type="text" value="443"/>
HTTP to HTTPS Redirection	<input checked="" type="checkbox"/>
Admin Username	<input type="text" value="admin"/>
Admin Password	<input type="text" value="25db591396e0"/> <input type="button" value="Generate"/>

Web Administration Settings

Enable	Check the box to allow the Pepwave router to manage the web admin access information of the AP.
Web Access Protocol	These buttons specify the web access protocol used for accessing the web admin of the AP. The two available options are HTTP and HTTPS .
Management Port	This field specifies the management port used for accessing the device.
HTTP to HTTPS Redirection	This option will be available if you have chosen HTTPS as the Web Access Protocol . With this enabled, any HTTP access to the web admin will redirect to HTTPS automatically.
Admin User Name	This field specifies the administrator username of the web admin. It is set as <i>admin</i> by default.
Admin Password	This field allows you to specify a new administrator password. You may also click the Generate button and let the system generate a random password automatically.

Navigating to **AP>Settings** on some Pepwave models displays a screen similar to the one shown below:

 InControl management enabled. Settings can now be configured on [InControl](#).

Wi-Fi Radio Settings	
Operating Country	United States
Wi-Fi Antenna	<input type="radio"/> Internal <input checked="" type="radio"/> External
Wi-Fi AP Settings 	
Protocol	802.11ng
Channel	1 (2.412 GHz)
Channel Width	Auto
Output Power	Max <input type="checkbox"/> Boost
Beacon Rate	 1Mbps
Beacon Interval	 100ms
DTIM	 1
Slot Time	 9 μ s
ACK Timeout	 48 μ s
Frame Aggregation	<input checked="" type="checkbox"/> Enable
Guard Interval	<input type="radio"/> Short <input type="radio"/> Long

Wi-Fi Radio Settings

Operating Country	This option sets the country whose regulations the Pepwave router follows.
Wi-Fi Antenna	Choose from the router's internal or optional external antennas, if so equipped.

Important Note

Per FCC regulations, the country selection is not available on all models marketed in the US. All US models are fixed to US channels only.

Wi-Fi AP Settings

Protocol	This option allows you to specify whether 802.11b and/or 802.11g client association requests will be accepted. Available options are 802.11ng and 802.11na . By default, 802.11ng is selected.
Channel	This option allows you to select which 802.11 RF channel will be used. Channel 1 (2.412 GHz) is selected by default.
Channel Width	Auto (20/40 MHz) and 20 MHz are available. The default setting is Auto (20/40 MHz) , which allows both widths to be used simultaneously.
Output Power	This option is for specifying the transmission output power for the Wi-Fi AP. There are 4 relative power levels available – Max, High, Mid, and Low . The actual output power will be bound by the regulatory limits of the selected country.
Beacon Rate^A	This option is for setting the transmit bit rate for sending a beacon. By default, 1Mbps is selected.
Beacon Interval^A	This option is for setting the time interval between each beacon. By default, 100ms is selected.
DTIM^A	This field allows you to set the frequency for the beacon to include a delivery traffic indication message. The interval is measured in milliseconds. The default value is set to 1 ms .
Slot Time^A	This field is for specifying the wait time before the Router transmits a packet. By default, this field is set to 9 μs .
ACK Timeout^A	This field is for setting the wait time to receive an acknowledgement packet before performing a retransmission. By default, this field is set to 48 μs .
Frame Aggregation^A	This option allows you to enable frame aggregation to increase transmission throughput.
Guard Interval^A	This setting allows choosing a short or long guard period interval for your transmissions.

^A - Advanced feature, please click the  button on the top right-hand corner to activate.

23 AP Controller Status

23.1 Info

A comprehensive overview of your AP can be accessed by navigating to **AP > Controller Status > Info**.



AP Controller	
License Limit	This field displays the maximum number of AP your Balance router can control. You can purchase licenses to increase the number of AP you can manage.
Frequency	Underneath, there are two check boxes labeled 2.4 Ghz and 5 Ghz . Clicking either box will toggle the display of information for that frequency. By default, the graphs display the number of clients and data usage for both 2.4GHz and 5 GHz frequencies.
SSID	The colored boxes indicate the SSID to display information for. Clicking any colored box will toggle the display of information for that SSID. By default, all the graphs show information for all SSIDs.

No. of APs	This pie chart and table indicates how many APs are online and how many are offline.
No. of Clients	This graph displays the number of clients connected to each network at any given time. Mouse over any line on the graph to see how many clients connected to a specific SSID for that point in time.
Data Usage	This graph enables you to see the data usage of any SSID for any given time period. Mouse over any line on the graph to see the data usage by each SSID for that point in time. Use the buttons next to Zoom to select the time scale you wish to view. In addition, you could use the sliders at the bottom to further refine your timescale.

Events		View Alerts
Jan 2 11:01:11	AP One 300M: Client 54:EA:A8:2D:A0:D5 disassociated from Marketing_11a	
Jan 2 11:00:42	AP One 300M: Client 54:EA:A8:2D:A0:D5 associated with Marketing_11a	
Jan 2 11:00:38	AP One 300M: Client 54:EA:A8:2D:A0:D5 disassociated from Marketing_11a	
Jan 2 11:00:36	AP One 300M: Client 00:21:6A:35:59:A4 associated with Balance_11a	
Jan 2 11:00:20	AP One 300M: Client 60:67:20:24:B6:4C disassociated from Marketing_11a	
Jan 2 11:00:09	AP One 300M: Client 54:EA:A8:2D:A0:D5 associated with Marketing_11a	
Jan 2 10:59:09	AP One 300M: Client 00:21:6A:35:59:A4 disassociated from Balance_11a	
Jan 2 10:59:08	Office Fiber AP: Client 18:00:2D:3D:4E:7F associated with Balance	
Jan 2 10:58:53	Michael's Desk: Client 18:00:2D:3D:4E:7F disassociated from Wireless	
Jan 2 10:58:18	AP One 300M: Client 54:EA:A8:2D:A0:D5 disassociated from Marketing_11a	
Jan 2 10:58:03	Office InWall: Client 10:BF:48:E9:76:C7 associated with Wireless	
Jan 2 10:57:47	AP One 300M: Client 54:EA:A8:2D:A0:D5 associated with Marketing_11a	
Jan 2 10:57:19	AP One 300M: Client 54:EA:A8:2D:A0:D5 disassociated from Marketing_11a	
Jan 2 10:57:09	AP One 300M: Client 54:EA:A8:2D:A0:D5 associated with Marketing_11a	
Jan 2 10:56:48	AP One 300M: Client 54:EA:A8:2D:A0:D5 disassociated from Marketing_11a	
Jan 2 10:56:39	AP One 300M: Client 54:EA:A8:2D:A0:D5 associated with Marketing_11a	
Jan 2 10:56:19	AP One 300M: Client 00:26:BB:05:84:A4 associated with Marketing_11a	
Jan 2 10:56:09	AP One 300M: Client 9C:04:EB:10:39:4C associated with Marketing_11a	
Jan 2 10:55:42	AP One 300M: Client 54:EA:A8:2D:A0:D5 disassociated from Marketing_11a	
Jan 2 10:55:29	AP One 300M: Client 54:EA:A8:2D:A0:D5 associated with Marketing_11a	
		More...

Events

This event log displays all activity on your AP network, down to the client level. Click **View Alerts** to see only alerts, and click the **More...** link for additional records.

23.2 Access Point (Usage)

A detailed breakdown of data usage for each AP is available at **AP > Controller Status > Access Point**.

Search Filter

AP Name / Serial Number / SSID	All
	<input type="checkbox"/> Include Offline APs
Search Result	

Managed APs Expand Collapse

Name	IP Address	MAC	Location	Firmware Pack ID	Configuration
▼ Default (8/9 online)					
100-101P-0000	10.8.82.11	00:1A:DD:BD:73:E0	-	3.5.2 None	✓ -

Usage

AP Name/Serial Number This field enables you to quickly find your device if you know its name or serial number. Fill in the field to begin searching. Partial names and serial numbers are supported.

Online Status This button toggles whether your search will include offline devices.

This table shows the detailed information on each AP, including channel, number of clients, upload traffic, and download traffic. Click the blue arrows at the left of the table to expand and collapse information on each device group. You could also expand and collapse all groups by using the Expand Collapse buttons.

On the right of the table, you will see the following icons: .

Click the icon to see a usage table for each client:

Client List Close

MAC Address	IP Address	Type	Signal	SSID	Upload	Download
80:56:f2:98:75:ff	10.9.2.7	802.11ng	Excellent (37)	Balance	66.26 MB	36.26 MB
c4:6a:b7:bf:d7:15	10.9.2.123	802.11ng	Excellent (42)	Balance	6.65 MB	2.26 MB
70:56:81:1d:87:f3	10.9.2.102	802.11ng	Good (23)	Balance	1.86 MB	606.63 KB
e0:63:e5:83:45:c6	10.9.2.101	802.11ng	Excellent (39)	Balance	3.42 MB	474.52 KB
18:00:2d:3d:4e:7f	10.9.2.66	802.11ng	Excellent (25)	Balance	640.29 KB	443.57 KB
14:5a:05:80:4f:40	10.9.2.76	802.11ng	Excellent (29)	Balance	2.24 KB	3.67 KB
00:1a:dd:c5:4e:24	10.8.9.84	802.11ng	Excellent (29)	Wireless	9.86 MB	9.76 MB
00:1a:dd:bb:29:ec	10.8.9.73	802.11ng	Excellent (25)	Wireless	9.36 MB	11.14 MB
40:b0:fa:c3:26:2c	10.8.9.18	802.11ng	Good (23)	Wireless	118.05 MB	7.92 MB
e4:25:e7:8a:d3:12	10.10.11.23	802.11ng	Excellent (35)	Marketing	74.78 MB	4.58 MB
04:f7:e4:ef:68:05	10.10.11.71	802.11ng	Poor (12)	Marketing	84.84 KB	119.32 KB

Close

Managed Wireless Devices

Click the icon to configure each client

AP Details ✕

Serial Number	1111-2222-3333		
MAC Address	00:1A:DD:BD:73:E0		
Product Name	Pepwave AP Pro Duo		
Name	<input type="text"/>		
Location	<input type="text"/>		
Firmware Version	3.5.2		
Firmware Pack	Default (None) ▼		
AP Client Limit	<input checked="" type="radio"/> Follow AP Profile <input type="radio"/> Custom		
2.4 GHz SSID List	T4Open		
5 GHz SSID List	T4Open		
Last config applied by controller	Mon Nov 23 11:25:03 HKT 2015		
Uptime	Wed Nov 11 15:00:27 HKT 2015		
Current Channel	1 (2.4 GHz) 153 (5 GHz)		
Channel	2.4 GHz: Follow AP Profile ▼	5 GHz: Follow AP Profile ▼	
Output Power	2.4 GHz: Follow AP Profile ▼	5 GHz: Follow AP Profile ▼	

For easier network management, you can give each client a name and designate its location. You can also designate which firmware pack (if any) this client will follow, as well as the channels on which the client will broadcast.

Click the icon to see a graph displaying usage:

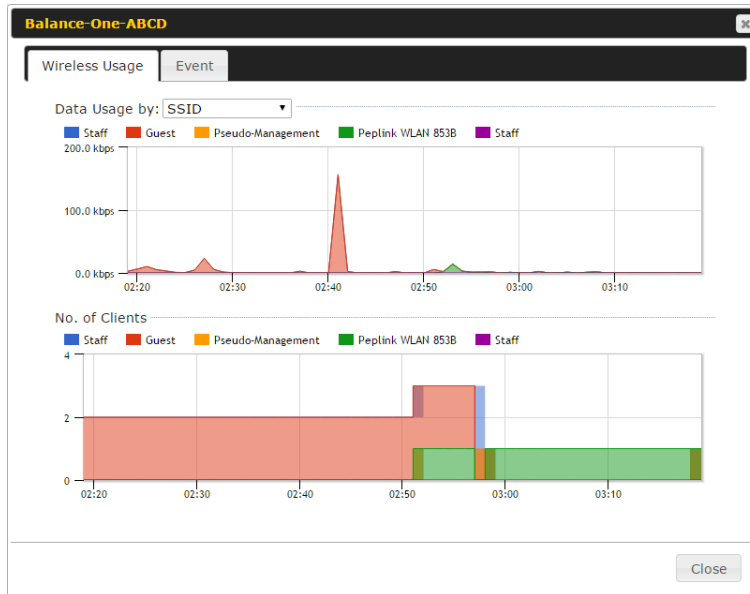

Click any point in the graphs to display detailed usage and client information for that device, using that SSID, at that point in time. On the **Data Usage by** menu, you can display the information by SSID or by AP send/receive rate.

Click the **Event** tab next to **Wireless Usage** to view a detailed event log for that particular device:

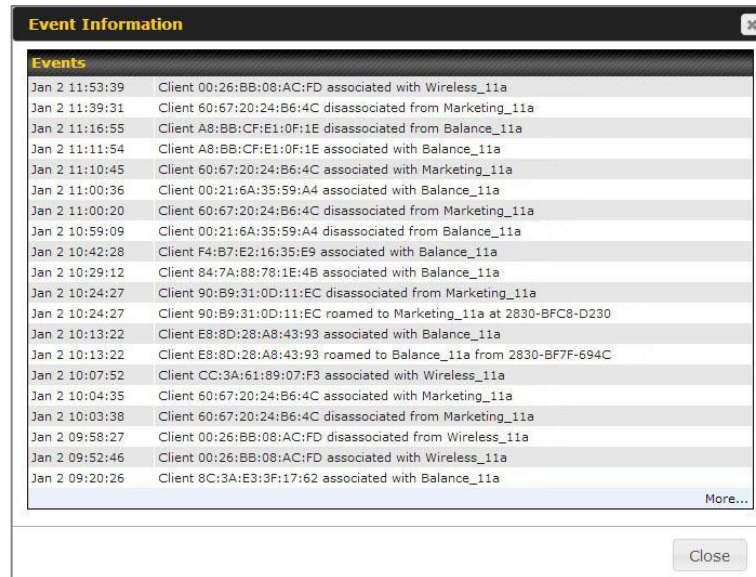

Event Information	
Events	
Jan 2 11:53:39	Client 00:26:BB:08:AC:FD associated with Wireless_11a
Jan 2 11:39:31	Client 60:67:20:24:B6:4C disassociated from Marketing_11a
Jan 2 11:16:55	Client A8:BB:CF:E1:0F:1E disassociated from Balance_11a
Jan 2 11:11:54	Client A8:BB:CF:E1:0F:1E associated with Balance_11a
Jan 2 11:10:45	Client 60:67:20:24:B6:4C associated with Marketing_11a
Jan 2 11:00:36	Client 00:21:6A:35:59:A4 associated with Balance_11a
Jan 2 11:00:20	Client 60:67:20:24:B6:4C disassociated from Marketing_11a
Jan 2 10:59:09	Client 00:21:6A:35:59:A4 disassociated from Balance_11a
Jan 2 10:42:28	Client F4:B7:E2:16:35:E9 associated with Balance_11a
Jan 2 10:29:12	Client 84:7A:88:78:1E:4B associated with Balance_11a
Jan 2 10:24:27	Client 90:B9:31:0D:11:EC disassociated from Marketing_11a
Jan 2 10:24:27	Client 90:B9:31:0D:11:EC roamed to Marketing_11a at 2830-BFC8-D230
Jan 2 10:13:22	Client E8:8D:28:A8:43:93 associated with Balance_11a
Jan 2 10:13:22	Client E8:8D:28:A8:43:93 roamed to Balance_11a from 2830-BF7F-694C
Jan 2 10:07:52	Client CC:3A:61:89:07:F3 associated with Wireless_11a
Jan 2 10:04:35	Client 60:67:20:24:B6:4C associated with Marketing_11a
Jan 2 10:03:38	Client 60:67:20:24:B6:4C disassociated from Marketing_11a
Jan 2 09:58:27	Client 00:26:BB:08:AC:FD disassociated from Wireless_11a
Jan 2 09:52:46	Client 00:26:BB:08:AC:FD associated with Wireless_11a
Jan 2 09:20:26	Client 8C:3A:E3:3F:17:62 associated with Balance_11a

23.3 Wireless SSID

In-depth SSID reports are available under **AP > Controller Status > Wireless SSID**.

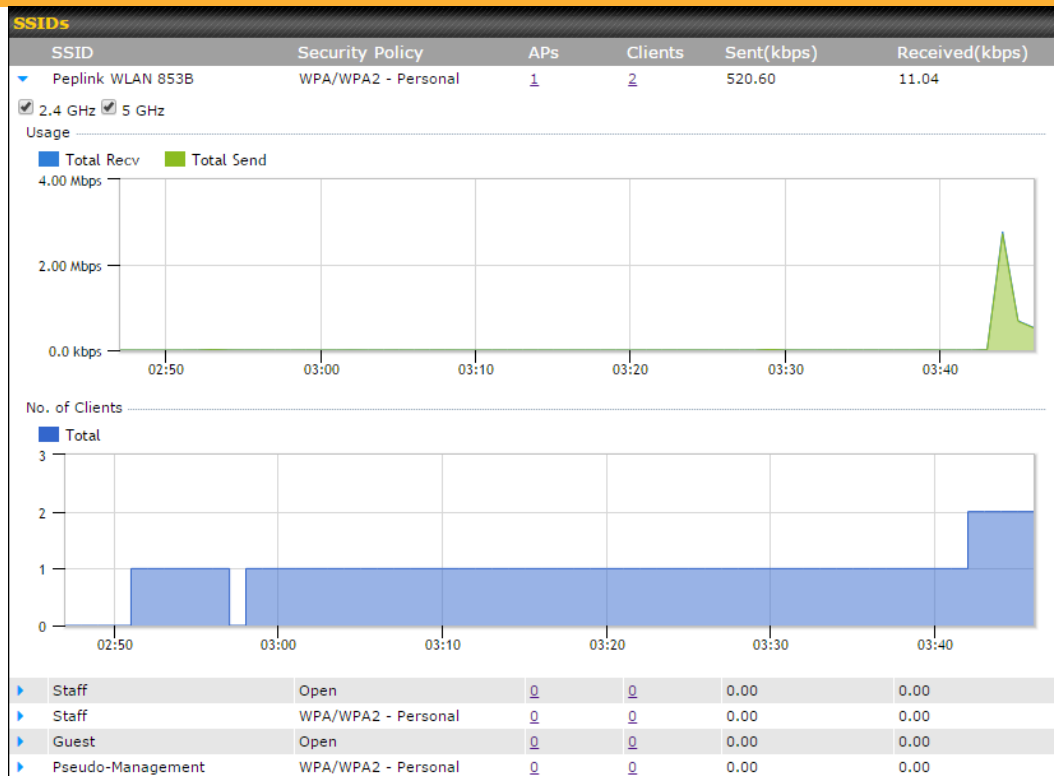

Click the blue arrow on any SSID to obtain more detailed usage information on each SSID.

23.4 Wireless Client

You can search for specific Wi-Fi users by navigating to **AP > Controller Status > Wireless Client**.

Search Filter

Client MAC / SSID / AP Serial Number

Maximum Result (1-256)

Search Result

Top 10 Clients of last hour (Updated at 03:00)

Client MAC Address	Upload	Download
C0:EE:FB:20:13:36	53.5 KB	101.4 KB

Here, you will be able to see your network’s heaviest users as well as search for specific users. Click the ☆ icon to bookmark specific users, and click the 📊 icon for additional details about each user:

Client C0:EE:FB:20:13:36 ✕

Information	
Status	Associated
Access Point	1111-2222-3333
SSID	Peplink WLAN 853B
IP Address	192.168.1.34
Duration	00:27:31
Usage (Upload / Download)	141.28 MB / 4.35 MB
RSSI	-48
Rate (Upload / Download)	150M / 48M
Type	802.11na

■ Download ■ Upload

SSID	AP	From	To	Upload	Download
Peplink WLAN 853B	192C-1835-642F	Nov 23 03:43:04	-	141.28 MB	4.35 MB
Peplink WLAN 853B	192C-1835-642F	Nov 23 02:58:36	Nov 23 03:47:52	173.7 KB	94.2 KB
Peplink WLAN 853B	192C-1835-642F	Nov 23 02:52:15	Nov 23 02:58:15	105.9 KB	62.5 KB

Close

23.5 Nearby Device

A listing of near devices can be accessed by navigating to **AP > Controller Status > Nearby Device**.

Suspected Rogue APs					
BSSID	SSID	Channel	Encryption	Last Seen	Mark as
00:1A:DD:EC:25:22	Wireless	11	WPA2	10 hours ago	
00:1A:DD:EC:25:23	Accounting	11	WPA2	10 hours ago	
00:1A:DD:EC:25:24	Marketing	11	WPA2	11 hours ago	
00:03:7F:00:00:00	MYB1PUSH	1	WPA & WPA2	11 minutes ago	
00:03:7F:00:00:01	MYB1	1	WPA2	15 minutes ago	
00:1A:DD:B9:60:88	PEPWAVE_CB7E	1	WPA & WPA2	5 minutes ago	
00:1A:DD:BB:09:C1	Micro_S1_1	6	WPA & WPA2	1 hour ago	
00:1A:DD:BB:52:A8	MAX HD2 Gobi	11	WPA & WPA2	2 minutes ago	
00:1A:DD:BF:75:81	PEPLINK_05B5	4	WPA & WPA2	1 minute ago	
00:1A:DD:BF:75:82	LK_05B5	4	WPA2	1 minute ago	
00:1A:DD:BF:75:83	LK_05B5_VLAN22	4	WPA2	1 minute ago	
00:1A:DD:C1:ED:E4	dev_captive_portal_test	1	WPA & WPA2	3 minutes ago	
00:1A:DD:C2:E4:C5	PEPWAVE_7052	11	WPA & WPA2	2 hours ago	
00:1A:DD:C3:F1:64	dev_captive_portal_test	6	WPA & WPA2	6 minutes ago	
00:1A:DD:C4:DC:24	ssid_test	8	WPA & WPA2	2 minutes ago	
00:1A:DD:C4:DC:25	SSID New	8	WPA & WPA2	2 minutes ago	
00:1A:DD:C5:46:04	Guest SSID	9	WPA2	2 minutes ago	
00:1A:DD:C5:47:04	PEPWAVE_67B8	1	WPA & WPA2	5 minutes ago	
00:1A:DD:C5:4E:24	G BR1 Portal	2	WPA2	2 minutes ago	
00:1A:DD:C6:9A:48	ssid_test	8	WPA & WPA2	2 hours ago	

Suspected Rogue Devices

Hovering over the device MAC address will result in a popup with information on how this device was detected. Click the icons and the device will be moved to the bottom table of identified devices.

23.6 Event Log

You can access the AP Controller Event log by navigating to **AP > Controller Status > Event Log**.

Filter	
Search key	<input type="text" value="Client MAC Address / Wireless SSID / AP Serial Number / AP Profile Name"/>
Time	From <input type="text"/> hh:mm to <input type="text"/> hh:mm
Alerts only	<input type="checkbox"/>
<input type="button" value="Search"/>	

Events		View Alerts
Jan 2 11:01:11	AP One 300M: Client 54:EA:A8:2D:A0:D5 disassociated from Marketing_11a	
Jan 2 11:00:42	AP One 300M: Client 54:EA:A8:2D:A0:D5 associated with Marketing_11a	
Jan 2 11:00:38	AP One 300M: Client 54:EA:A8:2D:A0:D5 disassociated from Marketing_11a	
Jan 2 11:00:36	AP One 300M: Client 00:21:6A:35:59:A4 associated with Balance_11a	
Jan 2 11:00:20	AP One 300M: Client 60:67:20:24:B6:4C disassociated from Marketing_11a	
Jan 2 11:00:09	AP One 300M: Client 54:EA:A8:2D:A0:D5 associated with Marketing_11a	
Jan 2 10:59:09	AP One 300M: Client 00:21:6A:35:59:A4 disassociated from Balance_11a	
Jan 2 10:59:08	Office Fiber AP: Client 18:00:2D:3D:4E:7F associated with Balance	
Jan 2 10:58:53	Michael's Desk: Client 18:00:2D:3D:4E:7F disassociated from Wireless	
Jan 2 10:58:18	AP One 300M: Client 54:EA:A8:2D:A0:D5 disassociated from Marketing_11a	
Jan 2 10:58:03	Office InWall: Client 10:BF:48:E9:76:C7 associated with Wireless	
Jan 2 10:57:47	AP One 300M: Client 54:EA:A8:2D:A0:D5 associated with Marketing_11a	
Jan 2 10:57:19	AP One 300M: Client 54:EA:A8:2D:A0:D5 disassociated from Marketing_11a	
Jan 2 10:57:09	AP One 300M: Client 54:EA:A8:2D:A0:D5 associated with Marketing_11a	
Jan 2 10:56:48	AP One 300M: Client 54:EA:A8:2D:A0:D5 disassociated from Marketing_11a	
Jan 2 10:56:39	AP One 300M: Client 54:EA:A8:2D:A0:D5 associated with Marketing_11a	
Jan 2 10:56:19	AP One 300M: Client 00:26:BB:05:84:A4 associated with Marketing_11a	
Jan 2 10:56:09	AP One 300M: Client 9C:04:EB:10:39:4C associated with Marketing_11a	
Jan 2 10:55:42	AP One 300M: Client 54:EA:A8:2D:A0:D5 disassociated from Marketing_11a	
Jan 2 10:55:29	AP One 300M: Client 54:EA:A8:2D:A0:D5 associated with Marketing_11a	

[More...](#)

Events

This event log displays all activity on your AP network, down to the client level. Use to filter box to search by MAC address, SSID, AP Serial Number, or AP Profile name. Click **View Alerts** to see only alerts, and click the **More...** link for additional records.

24 Toolbox

Tools for managing firmware packs can be found at **AP>Toolbox**.

Firmware Packs			
Pack ID	Release Date	Details	Action
1126	2013-08-26		

No default defined.

Firmware Packs

Here, you can manage the firmware of your AP. Clicking on will result in information regarding each firmware pack. To receive new firmware packs, you can click **Check for Updates** to download new packs, or you can click **Manual Upload** to manually upload a firmware pack. Click **Default** to define which firmware pack is default.

25 System Settings

25.1 Admin Security

There are two types of user accounts available for accessing the web admin: *admin* and *user*. They represent two user levels: the admin level has full administration access, while the user level is read-only. The user level can access only the device's status information; users cannot make any changes on the device.

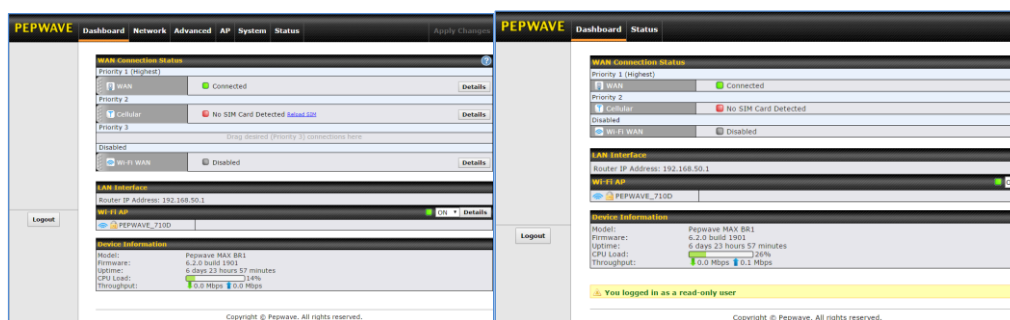

Admin account UI

User account UI

A web login session will be logged out automatically when it has been idle longer than the **Web Session Timeout**. Before the session expires, you may click the **Logout** button in the web admin to exit the session.

0 hours 0 minutes signifies an unlimited session time. This setting should be used only in special situations, as it will lower the system security level if users do not log out before closing the browser. The **default** is 4 hours, 0 minutes.

For security reasons, after logging in to the web admin Interface for the first time, it is recommended to change the administrator password. Configuring the administration interface to be accessible only from the LAN can further improve system security. Administrative settings configuration is located at **System>Admin Security**.

Admin Settings ?	
Router Name	MAX_BR1_710D hostname: max-br1-710d
Admin User Name	admin
Admin Password	••••••••
Confirm Admin Password	••••••••
Read-only User Name	user
User Password	
Confirm User Password	
Web Session Timeout	? 4 Hours 0 Minutes
Authentication by RADIUS	? <input checked="" type="checkbox"/> Enable
Auth Protocol	MS-CHAP v2 ▾
Auth Server	<input type="text"/> Port <input type="text"/> Default
Auth Server Secret	<input type="text"/> <input checked="" type="checkbox"/> Hide Characters
Auth Timeout	3 seconds
Accounting Server	<input type="text"/> Port <input type="text"/> Default
Accounting Server Secret	<input type="text"/> <input checked="" type="checkbox"/> Hide Characters
CLI SSH	? <input checked="" type="checkbox"/> Enable
CLI SSH Port	8822 Default
CLI SSH Access	LAN/WAN ▾
Security	HTTP ▾
Web Admin Port	80 Default
Web Admin Access	LAN Only ▾

Admin Settings	
Router Name	This field allows you to define a name for this Pepwave router. By default, Router Name is set as MAX_XXXX , where XXXX refers to the last 4 digits of the unit's serial number.
Admin User Name	Admin User Name is set as <i>admin</i> by default, but can be changed, if desired.
Admin Password	This field allows you to specify a new administrator password.
Confirm Admin Password	This field allows you to verify and confirm the new administrator password.
Read-only User Name	Read-only User Name is set as <i>user</i> by default, but can be changed, if desired.
User Password	This field allows you to specify a new user password. Once the user password is set, the read-only user feature will be enabled.

Confirm User Password	This field allows you to verify and confirm the new user password.
Web Session Timeout	This field specifies the number of hours and minutes that a web session can remain idle before the Pepwave router terminates its access to the web admin interface. By default, it is set to 4 hours .
Authentication by RADIUS	With this box is checked, the web admin will authenticate using an external RADIUS server. Authenticated users are treated as either "admin" with full read-write permission or "user" with read-only access. Local admin and user accounts will be disabled. When the device is not able to communicate with the external RADIUS server, local accounts will be enabled again for emergency access. Additional authentication options will be available once this box is checked.
Auth Protocol	This specifies the authentication protocol used. Available options are MS-CHAP v2 and PAP .
Auth Server	This specifies the access address and port of the external RADIUS server.
Auth Server Secret	This field is for entering the secret key for accessing the RADIUS server.
Auth Timeout	This option specifies the time value for authentication timeout.
Accounting Server	This specifies the access address and port of the external accounting server.
Accounting Server Secret	This field is for entering the secret key for accessing the accounting server.
Network Connection	This option is for specifying the network connection to be used for authentication. Users can choose from LAN, WAN, and VPN connections.
CLI SSH	The CLI (command line interface) can be accessed via SSH. This field enables CLI support. For additional information regarding CLI, please refer to Section 21.16 .
CLI SSH Port	This field determines the port on which clients can access CLI SSH.
CLI SSH Access	This menu allows you to choose between granting access to LAN and WAN clients, or to LAN clients only.
Security	This option is for specifying the protocol(s) through which the web admin interface can be accessed: <ul style="list-style-type: none"> • HTTP • HTTPS • HTTP/HTTPS
Web Admin	This field is for specifying the port number on which the web admin interface can be accessed.

Port

Web Admin Access

This option is for specifying the network interfaces through which the web admin interface can be accessed:

- LAN only
- LAN/WAN

If LAN/WAN is chosen, the **WAN Connection Access Settings** form will be displayed.

LAN Connection Access Settings

Allowed LAN Networks

This field allows you to permit only specific networks or VLANs to access the Web UI.

WAN Connection Access Settings

Allowed Source IP Subnets

This field allows you to restrict web admin access only from defined IP subnets.

- **Any** - Allow web admin accesses to be from anywhere, without IP address restriction.
- **Allow access from the following IP subnets only** - Restrict web admin access only from the defined IP subnets. When this is chosen, a text input area will be displayed beneath:

The allowed IP subnet addresses should be entered into this text area. Each IP subnet

must be in form of $w.x.y.z/m$, where $w.x.y.z$ is an IP address (e.g., $192.168.0.0$), and m is the subnet mask in CIDR format, which is between 0 and 32 inclusively (For example, $192.168.0.0/24$).

To define multiple subnets, separate each IP subnet one in a line. For example:

- 192.168.0.0/24
- 10.8.0.0/16

This is to choose which WAN IP address(es) the web server should listen on.

Allowed WAN IP Address(es)

25.2 Firmware

Pepwave router firmware is upgradeable through the web admin interface. Firmware upgrade functionality is located at **System>Firmware**.

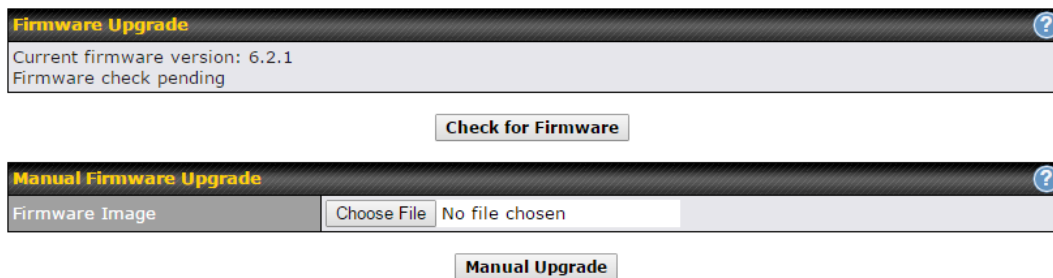

There are two ways to upgrade the unit. The first method is through an online download. The second method is to upload a firmware file manually.

To perform an online download, click on the **Check for Firmware** button. The Pepwave router will check online for new firmware. If new firmware is available, the Pepwave router will automatically download the firmware. The rest of the upgrade process will be automatically initiated.

You may also download a firmware image from the Peplink website and update the unit manually. To update using a firmware image, click **Choose File** to select the firmware file from the local computer, and then click **Manual Upgrade** to send the firmware to the Pepwave router. It will then automatically initiate the firmware upgrade process.

Please note that all Peplink devices can store two different firmware versions in two different partitions. A firmware upgrade will always replace the inactive partition. If you want to keep the inactive firmware, you can simply reboot your device with the inactive firmware and then perform the firmware upgrade.

Important Note

The firmware upgrade process may not necessarily preserve the previous configuration, and the behavior varies on a case-by-case basis. Consult the release notes for the particular firmware version before installing. Do not disconnect the power during firmware upgrade process. Do not attempt to upload a non-firmware file or a firmware file that is not supported by Peplink. Upgrading the Pepwave router with an invalid firmware file will damage the unit and may void the warranty.

Important Note

If the firmware is rolled back from 5.x to 4.x, the configurations will be lost.

25.3 Time

Time Settings enables the system clock of the Pepwave router to be synchronized with a specified time server. Time settings are located at **System>Time**.

Time Settings	
Time Zone	(GMT+07:00) Krasnoyarsk <input type="checkbox"/> Show all
Time Server	0.peplink.pool.ntp.org <input type="button" value="Default"/>
<input type="button" value="Save"/>	

Time Settings

Time Zone

This specifies the time zone (along with the corresponding Daylight Savings Time scheme). The **Time Zone** value affects the time stamps in the Pepwave router's event log and e-mail notifications. Check **Show all** to show all time zone options.

Time Server

This setting specifies the NTP network time server to be utilized by the Pepwave router.

25.4 Schedule

Enable and disable different functions (such as WAN connections, outbound policy, and firewalls at different times, based on a user-scheduled configuration profile. The settings for this are located at **System > Schedule**

Schedule			
Enabled			
Name	Time	Used by	
Weekdays Only	Weekdays only	-	
New Schedule			

Enable scheduling, and then click on your schedule name or on the **New Schedule** button to begin.

Edit schedule profile ✕

Schedule Settings

Enable	<input checked="" type="checkbox"/> <small>The schedule function of those associated features will be lost if profile is disabled.</small>
Name	<input type="text" value="Weekdays Only"/>
Schedule	<input type="text" value="Weekdays only"/>
Used by	<small>You may go to supported feature settings page and set this profile as scheduler.</small>

Schedule Map

	Midnight	4am	8am	Noon	4pm	8pm
Sunday	x	x	x	x	x	x
Monday	✓	✓	✓	✓	✓	✓
Tuesday	✓	✓	✓	✓	✓	✓
Wednesday	✓	✓	✓	✓	✓	✓
Thursday	✓	✓	✓	✓	✓	✓
Friday	✓	✓	✓	✓	✓	✓
Saturday	x	x	x	x	x	x

Edit Schedule Profile	
Enabling	Click this checkbox to enable this schedule profile. Note that if this is disabled, then any associated features will also have their scheduling disabled.
Name	Enter your desired name for this particular schedule profile.
Schedule	Click the drop-down menu to choose pre-defined schedules as your starting point. Please note that upon selection, previous changes on the schedule map will be deleted.

Schedule Map Click on the desired times to enable features at that time period. You can hold your mouse for faster entry.

25.5 Email Notification

Email notification functionality provides a system administrator with up-to-date information on network status. The settings for configuring email notifications are found at **System>Email Notification**.

Email Notification Setup	
Email Notification	<input checked="" type="checkbox"/> Enable
SMTP Server	smtp.mycompany.com <input checked="" type="checkbox"/> Require authentication
SSL Encryption	<input checked="" type="checkbox"/> (Note: any server certificate will be accepted)
SMTP Port	465 <input type="button" value="Default"/>
SMTP User Name	smtpuser
SMTP Password	••••••
Confirm SMTP Password	••••••
Sender's Email Address	idmin@mycompany.com
Recipient's Email Address	system@mycompany.com staff@mycompany.com

Email Notification Settings	
Email Notification	This setting specifies whether or not to enable email notification. If Enable is checked, the Pepwave router will send email messages to system administrators when the WAN status changes or when new firmware is available. If Enable is not checked, email notification is disabled and the Pepwave router will not send email messages.
SMTP Server	This setting specifies the SMTP server to be used for sending email. If the server requires authentication, check Require authentication .
SSL Encryption	Check the box to enable SMTPS. When the box is checked, SMTP Port will be changed to 465 automatically.
SMTP Port	This field is for specifying the SMTP port number. By default, this is set to 25 ; when SSL Encryption is checked, the default port number will be set to 465 . You may customize the port number by editing this field. Click Default to restore the number to its default setting.

SMTP User Name / Password	This setting specifies the SMTP username and password while sending email. These options are shown only if Require authentication is checked in the SMTP Server setting.
Confirm SMTP Password	This field allows you to verify and confirm the new administrator password.
Sender's Email Address	This setting specifies the email address the Pepwave router will use to send reports.
Recipient's Email Address	This setting specifies the email address(es) to which the Pepwave router will send email notifications. For multiple recipients, separate each email addresses using the enter key.

After you have finished setting up email notifications, you can click the **Test Email Notification** button to test the settings before saving. After **Test Email Notification** is clicked, you will see this screen to confirm the settings:

Test Email Notification	
SMTP Server	smtp.mycompany.com
SMTP Port	465
SMTP UserName	smtpuser
Sender's Email Address	admin@mycompany.com
Recipient's Email Address	system@mycompany.com staff@mycompany.com

Click **Send Test Notification** to confirm. In a few seconds, you will see a message with detailed test results.

Test email sent. Email notification settings are not saved, it will be saved after clicked the 'Save' button.

Test Result

```
[INFO] Try email through connection #3
[<-] 220 ESMTP
[->] EHLO balance
[<-] 250-smtp Hello balance [210.210.210.210]
250-SIZE 100000000
250-8BITMIME
250-PIPELINING
250-AUTH PLAIN LOGIN
250-STARTTLS
```

25.6 Event Log

Event log functionality enables event logging at a specified remote syslog server. The settings for configuring the remote system log can be found at **System>Event Log**.

Send Events to Remote Syslog Server	
Remote Syslog	<input checked="" type="checkbox"/>
Remote Syslog Host	<input type="text"/>
Push Events to Mobile Devices	
Push Events	<input checked="" type="checkbox"/>

Event Log Settings

Remote Syslog This setting specifies whether or not to log events at the specified remote syslog server.

Remote Syslog Host This setting specifies the IP address or hostname of the remote syslog server.



Push Events The Pepwave router can also send push notifications to mobile devices that have our Mobile Router Utility installed. Check the box to activate this feature.

For more information on the Router Utility, go to: www.peplink.com/products/router-utility

25.7 SNMP

SNMP or simple network management protocol is an open standard that can be used to collect information about the Pepwave router. SNMP configuration is located at **System>SNMP**.

SNMP Settings	
SNMP Device Name	MAX_HD2_8D1C
SNMP Port	161 <input type="button" value="Default"/>
SNMPv1	<input type="checkbox"/> Enable
SNMPv2c	<input type="checkbox"/> Enable
SNMPv3	<input type="checkbox"/> Enable
<input type="button" value="Save"/>	

Community Name	Allowed Source Network	Access Mode
No SNMPv1 / SNMPv2c Communities Defined		
<input type="button" value="Add SNMP Community"/>		

SNMPv3 User Name	Authentication / Privacy	Access Mode
No SNMPv3 Users Defined		
<input type="button" value="Add SNMP User"/>		

SNMP Settings	
SNMP Device Name	This field shows the router name defined at System>Admin Security .
SNMP Port	This option specifies the port which SNMP will use. The default port is 161 .
SNMPv1	This option allows you to enable SNMP version 1.
SNMPv2	This option allows you to enable SNMP version 2.
SNMPv3	This option allows you to enable SNMP version 3.

To add a community for either SNMPv1 or SNMPv2, click the **Add SNMP Community** button in the **Community Name** table, upon which the following screen is displayed:

SNMP Community ✕

Community Name	<input type="text" value="My Company"/>
Allowed Network	<input type="text" value="192.168.1.25"/> / <input type="text" value="255.255.255.0 (/24)"/> ▾

SNMP Community Settings	
Community Name	This setting specifies the SNMP community name.
Allowed Source Subnet Address	This setting specifies a subnet from which access to the SNMP server is allowed. Enter subnet address here (e.g., 192.168.1.0) and select the appropriate subnet mask.

To define a user name for SNMPv3, click **Add SNMP User** in the **SNMPv3 User Name** table,

The dialog box titled "SNMPv3 User" contains the following fields:

User Name	SNMPUser
Authentication	SHA <input type="text" value="password"/>
Privacy	DES <input type="text" value="privacypassword"/>

Buttons: Save, Cancel

upon which the following screen is displayed:

SNMPv3 User Settings	
User Name	This setting specifies a user name to be used in SNMPv3.
Authentication Protocol	<p>This setting specifies via a drop-down menu one of the following valid authentication protocols:</p> <ul style="list-style-type: none"> NONE MD5 SHA <p>When MD5 or SHA is selected, an entry field will appear for the password.</p>
Privacy Protocol	<p>This setting specifies via a drop-down menu one of the following valid privacy protocols:</p> <ul style="list-style-type: none"> NONE DES <p>When DES is selected, an entry field will appear for the password.</p>

25.8 InControl

InControl Management	
InControl Management	<input checked="" type="checkbox"/> Allow InControl Management
Privately Host InControl	<input checked="" type="checkbox"/>
InControl Host	<input type="text"/> <input type="text"/>

InControl is a cloud-based service which allows you to manage all of your Peplink and Pepwave devices with one unified system. With it, you can generate reports, gather statistics, and configure your devices automatically. All of this is now possible with InControl.

When this check box is checked, the device's status information will be sent to the Peplink InControl system. This device's usage data and configuration will be sent to the system if you enable the features in the system.

Alternately, you could also privately host InControl. Simply check the box beside the "Privately Host InControl" open, and enter the IP Address of your InControl Host.

You can sign up for an InControl account at <https://incontrol2.peplink.com/>. You can register your devices under the account, monitor their status, see their usage reports, and receive offline notifications.

25.9 Configuration

Backing up Pepwave router settings immediately after successful completion of initial setup is strongly recommended. The functionality to download and upload Pepwave router settings is found at **System>Configuration**. Note that available options vary by model.

Restore Configuration to Factory Settings ?

Download Active Configurations ?

Upload Configurations ?

Configuration File	<input type="button" value="Browse..."/> No file selected.
<input type="button" value="Upload"/>	

Upload Configurations from High Availability Pair ?

Configuration File	<input type="button" value="Browse..."/> No file selected.
<input type="button" value="Upload"/>	

Configuration	
Restore Configuration to Factory Settings	The Restore Factory Settings button is to reset the configuration to factory default settings. After clicking the button, you will need to click the Apply Changes button on the top right corner to make the settings effective.
Download Active Configurations	Click Download to backup the current active settings.
Upload Configurations	To restore or change settings based on a configuration file, click Choose File to locate the configuration file on the local computer, and then click Upload . The new settings can then be applied by clicking the Apply Changes button on the page header, or you can cancel the procedure by pressing discard on the main page of the web admin interface.
Upload Configurations from High Availability Pair	In a high availability (HA) configuration, a Pepwave router can quickly load the configuration of its HA counterpart. To do so, click the Upload button. After loading the settings, configure the LAN IP address of the Pepwve router so that it is different from the HA counterpart.

25.10 Feature Add-ons

Some Pepwave routers have features that can be activated upon purchase. Once the purchase is complete, you will receive an activation key. Enter the key in the **Activation Key** field, click **Activate**, and then click **Apply Changes**.

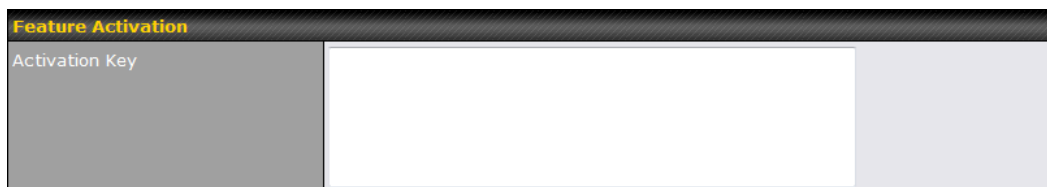

The screenshot shows a web interface titled "Feature Activation". It contains a single text input field with the placeholder text "Activation Key".

25.11 Reboot

This page provides a reboot button for restarting the system. For maximum reliability, the Pepwave router can equip with two copies of firmware. Each copy can be a different version. You can select the firmware version you would like to reboot the device with. The firmware marked with **(Running)** is the current system boot up firmware.

Please note that a firmware upgrade will always replace the inactive firmware partition.

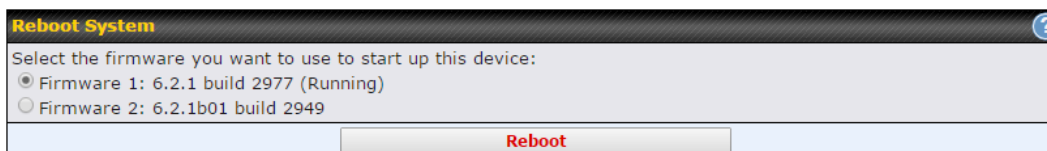

The screenshot shows a web interface titled "Reboot System" with a help icon. The text reads: "Select the firmware you want to use to start up this device:". There are two radio button options: "Firmware 1: 6.2.1 build 2977 (Running)" and "Firmware 2: 6.2.1b01 build 2949". A "Reboot" button is located at the bottom.

26 Tools

26.1 Ping

The ping test tool sends pings through a specified Ethernet interface or a SpeedFusion™ VPN connection. You can specify the number of pings in the field **Number of times**, to a maximum number of 10 times. **Packet Size** can be set to a maximum of 1472 bytes. The ping utility is located at **System>Tools>Ping**, illustrated below:

Ping	
Connection	WAN 1 ▾
Destination	10.10.10.1
Packet Size	56
Number of times	Times 5 

Results <input type="button" value="Clear Log"/>	
PING 10.10.10.1 (10.10.10.1) from 10.88.3.158 56(84) bytes of data.	
64 bytes from 10.10.10.1: icmp_req=1 ttl=62 time=27.6 ms	
64 bytes from 10.10.10.1: icmp_req=2 ttl=62 time=26.5 ms	
64 bytes from 10.10.10.1: icmp_req=3 ttl=62 time=28.9 ms	
64 bytes from 10.10.10.1: icmp_req=4 ttl=62 time=28.3 ms	
64 bytes from 10.10.10.1: icmp_req=5 ttl=62 time=27.7 ms	

--- 10.10.10.1 ping statistics ---	
5 packets transmitted, 5 received, 0% packet loss, time 4005ms	
rtt min/avg/max/mdev = 26.516/27.855/28.933/0.814 ms	

Tip

A system administrator can use the ping utility to manually check the connectivity of a particular LAN/WAN connection.

26.2 Traceroute Test

The traceroute test tool traces the routing path to the destination through a particular Ethernet interface or a SpeedFusion™ connection. The traceroute test utility is located at **System>Tools>Traceroute**.

PepVPN Throughput Test	
Profile	NY Office ▾
Type	<input checked="" type="radio"/> TCP <input type="radio"/> UDP
Direction	<input checked="" type="radio"/> Upload <input type="radio"/> Download
Duration	10 seconds (5 - 600)
<input type="button" value="Go!"/>	
Results	
(Empty)	

26.4 Wake-on-LAN

Peplink routers can send special “magic packets” to any client specified from the Web UI. To access this feature, navigate to **System > Tools > Wake-on-LAN**

Wake-on-LAN	
Wake-on-LAN Target	Surf_SOHO (00:90:0B:36:3C:8C) ▾ <input type="button" value="Send"/>

Select a client from the drop-down list and click **Send** to send a “magic packet”

26.5 CLI (Command Line Interface Support)

The CLI (command line interface) can be accessed via SSH. This field enables CLI support. The below settings specify which TCP port and which interface(s) should accept remote SSH CLI access. The user name and password used for remote SSH CLI access are the same as those used for web admin access.

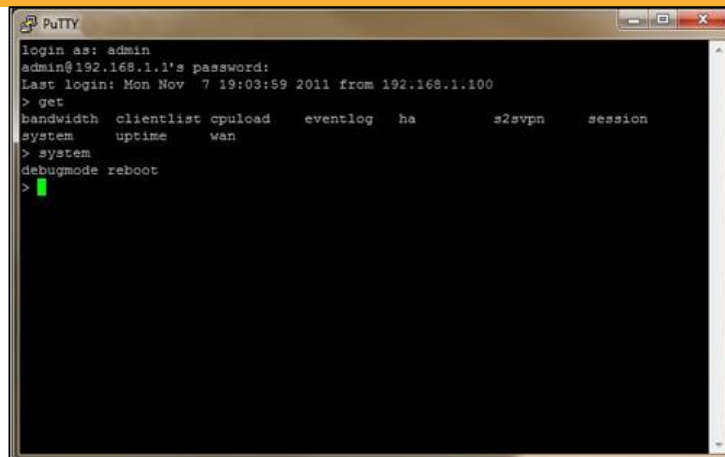

```
login as: admin
admin@192.168.1.1's password:
Last login: Mon Nov  7 19:03:59 2011 from 192.168.1.100
> get
bandwidth  clientlist  cpuload  eventlog  ha      s2svpn  session
system    uptime    wan
> system
debugmode reboot
> █
```

27 Status

27.1 Device

System information is located at **Status>Device**.

System Information	
Router Name	MAX_HD2_8D1C
Model	Pepwave MAX HD2
Hardware Revision	2
Serial Number	2830-A48A-8D1C
Firmware	6.2.0 build 2891
PepVPN Version	4.0.0
Modem Support Version	1017 (Modem Support List)
Host Name	max-hd2-8d1c
Uptime	7 days 50 minutes
System Time	Mon Feb 23 11:14:13 WET 2015
Diagnostic Report	Download
Remote Assistance	Turn on

System Information	
Router Name	This is the name specified in the Router Name field located at System>Admin Security .
Model	This shows the model name and number of this device.
Product Code	If your model uses a product code, it will appear here.
Hardware Revision	This shows the hardware version of this device.
Serial Number	This shows the serial number of this device.
Firmware	This shows the firmware version this device is currently running.
PepVPN Version	This shows the current PepVPN version.
Modem Support Version	This shows the modem support version. For a list of supported modems, click Modem Support List .

Host Name	The host name assigned to the Pepwave router appears here.
Uptime	This shows the length of time since the device has been rebooted.
System Time	This shows the current system time.
Diagnostic Report	The Download link is for exporting a diagnostic report file required for system investigation.
Remote Assistance	Click Turn on to enable remote assistance.

Interface	MAC Address
LAN	00:1A:DD:BD:54:40
WAN 1	00:1A:DD:BD:54:41
WAN 2	00:1A:DD:BD:54:42

The second table shows the MAC address of each LAN/WAN interface connected. To view your device's End User License Agreement (EULA), click .

Important Note

If you encounter issues and would like to contact the Pepwave Support Team (<http://www.pepwave.com/contact/>), please download the diagnostic report file and attach it along with a description of your issue. In Firmware 5.1 or before, the diagnostic report file can be obtained at **System>Reboot**.

27.2 GPS Data

The MAX HD2 and HD2 IP67 automatically store up to seven days of GPS location data in GPS eXchange format (GPX). To review this data using third-party applications, click **Status>Device** and then download your GPX file.

The Pepwave MAX BR1, HD2, and HD2 IP67 export real-time location data in NMEA format through the LAN IP address at TCP port 60660. It is accessible from the LAN or over a SpeedFusion connection. To access the data via a virtual serial port, install a virtual serial port driver. Visit <http://www.peplink.com/index.php?view=faq&id=294> to download the driver.

27.3 Active Sessions

Information on active sessions can be found at **Status>Active Sessions>Overview**.

Overview

Search

Session data captured within one minute. [Refresh](#)

Service	Inbound Sessions	Outbound Sessions
AIM/ICQ	0	1
Bittorrent	0	32
DNS	0	51
Flash	0	1
HTTPS	0	76
Jabber	0	5
MSN	0	11
NTP	0	4
QQ	0	1
Remote Desktop	0	3
SSH	0	12
SSL	0	64
XMPP	0	4
Yahoo	0	1

Interface	Inbound Sessions	Outbound Sessions
WAN 1	0	176
WAN 2	0	32
Wi-Fi WAN	0	51
Cellular 1	0	64
Cellular 2	0	0
USB	0	0

Top Clients

Client IP Address	Total Sessions
10.9.66.66	1069
10.9.98.144	147
10.9.2.18	63
10.9.66.14	56
10.9.2.26	33

This screen displays the number of sessions initiated by each application. Click on each service listing for additional information. This screen also indicates the number of sessions initiated by each WAN port. In addition, you can see which clients are initiating the most sessions.

You can also perform a filtered search for specific sessions. You can filter by subnet, port, protocol, and interface. To perform a search, navigate to **Status>Active Sessions>Search**.

Overview
Search

Session data captured within one minute. [Refresh](#)

IP / Subnet	Source or Destination ▾	255.255.255.255 (/32) ▾
Port	Source or Destination ▾	
Protocol / Service	TCP ▾	
Interface	<input type="checkbox"/> WAN 1 <input type="checkbox"/> WAN 2 <input type="checkbox"/> Wi-Fi WAN <input type="checkbox"/> Cellular 1 <input type="checkbox"/> Cellular 2 <input type="checkbox"/> USB <input type="checkbox"/> VPN	
Search		

Outbound

Protocol	Source IP	Destination IP	Service	Interface	Idle Time
No sessions					

Total searched results: 0

Inbound

Protocol	Source IP	Destination IP	Service	Interface	Idle Time
No sessions					

Total searched results: 0

Transit

Protocol	Source IP	Destination IP	Service	Interface	Idle Time
No sessions					

Total searched results: 0

This **Active Sessions** section displays the active inbound/outbound sessions of each WAN connection on the Pepwave router. A filter is available to sort active session information. Enter a keyword in the field or check one of the WAN connection boxes for filtering.

27.4 Client List

The client list table is located at **Status>Client List**. It lists DHCP and online client IP addresses, names (retrieved from the DHCP reservation table or defined by users), current download and upload rate, and MAC address.

Clients can be imported into the DHCP reservation table by clicking the button on the right. You can update the record after import by going to **Network>LAN**.

Filter	<input type="checkbox"/> Online Clients Only <input type="checkbox"/> DHCP Clients Only				
Client List					
IP Address	Name	Download (kbps)	Upload (kbps)	MAC Address	Import
192.168.1.100		0	0	00:50:56:99:E1:76	
Scale: <input checked="" type="radio"/> kbps <input type="radio"/> Mbps					

If the PPTP server (see **Section 19.2**), SpeedFusion™ (see **Section 12.1**), or AP controller (see **Section 20**) is enabled, you may see the corresponding connection name listed in the **Name** field.

27.5 WINS Client

The WINS client list table is located at **Status>WINS Client**.

WINS Client List	
Name	IP Address
UserA	10.9.2.1
UserB	10.9.30.1
UserC	10.9.2.4

The WINS client table lists the IP addresses and names of WINS clients. This option will only be available when you have enabled the WINS server (navigation: **Network>Interfaces>LAN**). The names of clients retrieved will be automatically matched into the Client List (see previous section). Click **Flush All** to flush all WINS client records.

WINS Client List	
Name	IP Address
UserA	10.9.2.1
UserB	10.9.30.1
UserC	10.9.2.4

27.6 UPnP / NAT-PMP

The table that shows the forwarded ports under UPnP and NAT-PMP protocols is located at **Status>UPnP/NAT-PMP**. This section appears only if you have enabled UPnP / NAT-PMP as mentioned in **Section 16.1.1**.

Forwarded Ports						
External ▲	Internal	Internal Address	Type	Protocol	Description	
47453	3392	192.168.1.100	UPnP	UDP	Application 031	
35892	11265	192.168.1.50	NAT-PMP	TCP	NAT-PMP 58	
4500	3560	192.168.1.20	UPnP	TCP	Application 013	
5921	236	192.168.1.30	UPnP	TCP	Application 047	
22409	8943	192.168.1.70	NAT-PMP	UDP	NAT-PMP 97	
2388	27549	192.168.1.40	UPnP	TCP	Application 004	

Click to delete a single UPnP / NAT-PMP record in its corresponding row. To delete all records, click **Delete All** on the right-hand side below the table.

Important Note

UPnP / NAT-PMP records will be deleted immediately after clicking the button or **Delete All**, without the need to click **Save** or **Confirm**.

27.7 SpeedFusion Status

Current SpeedFusion™ status information is located at **Status>SpeedFusion™**. Details about SpeedFusion™ connection peers appears as below:

PepVPN with SpeedFusion - Remote Peer Details				<input type="checkbox"/> Show disconnected profiles	
Search		<input type="text"/>			
Remote Peer ▲	Profile	Information			
▶ ADA0-FFFC-11F8	FH	192.168.77.0/24			
▶ 3ED2-8F63-1824	380-5 - NO NAT	192.168.3.0/24			

Click on the corresponding peer name to explore the WAN connection(s) status and subnet information of each VPN peer.

Remote Peer	Profile	Information
<ul style="list-style-type: none"> ADA0-FFFC-11F8 <ul style="list-style-type: none"> WAN 1 WAN 2 WAN 3 Total 	FH Rx: < 1 kbps Tx: < 1 kbps Rx: < 1 kbps Tx: < 1 kbps Rx: < 1 kbps Tx: < 1 kbps Rx: < 1 kbps Tx: 1.1 kbps	192.168.77.0/24 Drop rate: 0.0 pkt/s Latency: 1 ms Drop rate: 0.0 pkt/s Latency: 1 ms Drop rate: 0.0 pkt/s Latency: 1 ms Drop rate: 0.0 pkt/s
<ul style="list-style-type: none"> 3ED2-8F63-1824 <ul style="list-style-type: none"> WAN 1 WAN 2 WAN 3 Total 	380-5 - NO NAT Rx: < 1 kbps Tx: < 1 kbps Rx: < 1 kbps Tx: < 1 kbps Rx: < 1 kbps Tx: < 1 kbps Rx: 1.6 kbps Tx: < 1 kbps	192.168.3.0/24 Drop rate: 0.0 pkt/s Latency: 4 ms Drop rate: 0.0 pkt/s Latency: 4 ms Drop rate: 0.0 pkt/s Latency: 4 ms Drop rate: 0.0 pkt/s

Click the  button for a chart displaying real-time throughput, latency, and drop-rate information for each WAN connection.

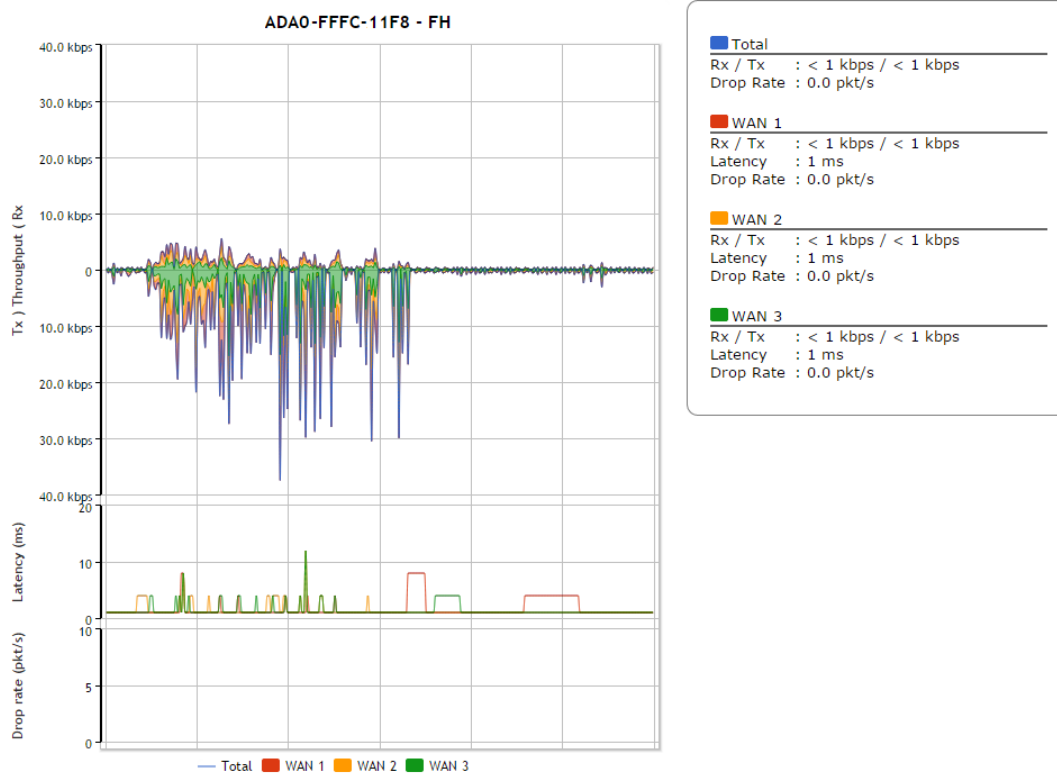

When pressing the  button, the following menu will appear:

PepVPN performance analysis - 9B0A-A29B-2931 ✕

PepVPN Test:
Check the general TCP/UDP throughput.

PepVPN Analyzer:
Check the uplink performance of each tunnel.

Warning: PepVPN Analyzer will temporarily interrupt VPN connectivity and will restore after test.

Close



PepVPN Test:
Check the general TCP/UDP throughput.

After clicking the icon, the following menu appears:

Configuration ?

Type	<input checked="" type="radio"/> TCP <input type="radio"/> UDP	Start
Direction	<input checked="" type="radio"/> Upload <input type="radio"/> Download	
Duration	10 seconds (5 - 600)	

WAN Statistics

● WAN 1	Rx: 2.5 kbps	Tx: 5.3 kbps	Drop rate: 0.0 pkt/s	Latency: 186 ms
● WAN 3	Rx: n/a	Tx: n/a	Drop rate: n/a	Latency: n/a
● WAN 4	Rx: n/a	Tx: n/a	Drop rate: n/a	Latency: n/a
Total	Rx: 2.5 kbps	Tx: 5.3 kbps	Drop rate: 0.0 pkt/s	Latency: 186 ms

Select the L2 protocol (TCP/UDP), direction, and duration and click the **Start** button to begin the general throughput test.

Results		
0.1250 MB / 1.00 sec =	1.0485 Mbps	
1.0000 MB / 1.00 sec =	8.3888 Mbps	
1.3125 MB / 1.00 sec =	11.0098 Mbps	
3.0000 MB / 1.00 sec =	25.1465 Mbps	
5.6875 MB / 1.00 sec =	47.7473 Mbps	
6.0625 MB / 1.00 sec =	50.8562 Mbps	
4.9375 MB / 1.00 sec =	41.4188 Mbps	
4.5000 MB / 1.00 sec =	37.7487 Mbps	
5.0000 MB / 1.00 sec =	41.9438 Mbps	
5.6875 MB / 1.00 sec =	47.7099 Mbps	
37.3167 MB / 10.05 sec = 31.1504 Mbps 8 %TX 9 %RX 47 retrans 132.62 msRTT		
TEST DONE		



PepVPN Analyzer:
Check the uplink performance of each tunnel.

The bandwidth bonding feature of PepVPN occurs when multiple WAN lines from one end merge with multiple WAN lines from the other end. For this to happen, each WAN line needs to form a connection with all the WAN lines on the opposite end. The function of the PepVPN analyzer is to report the throughput, packet loss, and latency of all possible combinations of connections. **Please note that the PepVPN Analyzer will temporarily interrupt VPN connectivity and will restore after test.**

After clicking the icon, the analyzer will require several minutes to perform its analysis depending the number of WAN links in the SpeedFusion™ Tunnel. Once the test the complete, the report will appear:

Results							
Estimated time: 150 s							
Time remaining: 0 s							
100%							
Local WAN1 > Remote WAN3	Local WAN1 > Remote WAN4	Local WAN1 > Remote WAN5	Local WAN1 > Remote WAN6	Tx Avg. (Mbps)	Tx Max. (Mbps)	Packet loss (%)	RTT (ms)
O				5.87	16.95	0.76	420.51
	O			20.72	26.39	1.59	29.89
		O		30.10	43.69	2.24	29.61
			O	45.01	55.93	2.16	28.24
O	O			24.87	33.56	0.86	49.86
O		O		19.30	31.28	0.01	49.78
	O	O		18.59	30.41	2.08	39.78
O	O	O		20.56	34.60	0.00	38.11
O			O	36.70	59.16	2.64	42.06
	O		O	19.98	30.40	4.40	38.01
O	O		O	31.63	42.99	0.72	37.99
		O	O	36.88	55.78	2.60	33.89
O		O	O	38.30	47.89	0.01	29.98
	O	O	O	33.21	55.23	2.69	30.48
O	O	O	O	30.02	46.66	3.77	28.68

"O" indicates that specific WAN / Tunnel is active for that particular test.

"Tx Avg." is the averaged throughput across the full 10 seconds time, while "Tx Max." is the averaged throughput of the fastest 30% of time.

27.8 Event Log

Event log information is located at **Status>Event Log**.

Device Event Log	
Device Event Log <input checked="" type="checkbox"/> Auto Refresh	
Feb 17 04:43:26	System: Changes applied
Feb 16 10:27:01	System: Time synchronization successful
Feb 16 10:26:25	WAN: WAN 1 connected (10.88.3.158)
Feb 16 10:26:01	WAN: Priority changed (Priority 1 - WAN 1, WAN 2 / Priority 2 - Cellular 1, Cellular 2 / Disabled - Wi-Fi WAN)
Feb 16 10:25:40	System: Started up (6.2.0 build 2891)
Feb 16 10:17:27	System: Changes applied
Feb 16 10:17:00	System: Time synchronization successful
Feb 16 10:19:23	WAN: WAN 1 connected (10.88.3.158)
Feb 16 10:18:58	WAN: Priority changed (Priority 1 - WAN 1, WAN 2 / Priority 2 - Cellular 1, Cellular 2 / Disabled - Wi-Fi WAN)
Feb 16 10:18:37	System: Started up (6.2.0.201501210247-r12145 build)
End of log	
<input type="button" value="Clear Log"/>	

The log section displays a list of events that has taken place on the Pepwave router. Check

Auto Refresh to refresh log entries automatically. Click the **Clear Log** button to clear the log.

28 Bandwidth Status

This section shows bandwidth usage statistics and is located at **Status>Bandwidth**. Bandwidth usage at the LAN while the device is switched off (e.g., LAN bypass) is neither recorded nor shown.

28.1 Real-Time

The **Data transferred since installation** table indicates how much network traffic has been processed by the device since the first bootup. The **Data transferred since last reboot** table indicates how much network traffic has been processed by the device since the last bootup.

Data transferred since installation (Sun Oct 10 05:56:02 PST 2010)

	Download	Upload	Total
All WAN Connections	216.68 GB	91.70 GB	308.38 GB

Data transferred since last reboot

[\[Hide Details \]](#)

	Download	Upload	Total
All WAN Connections	0.74 GB	0.63 GB	1.37 GB
WAN1	0.67 GB	0.61 GB	1.28 GB
WAN2	0.07 GB	0.02 GB	0.09 GB

Aggregated Transfer

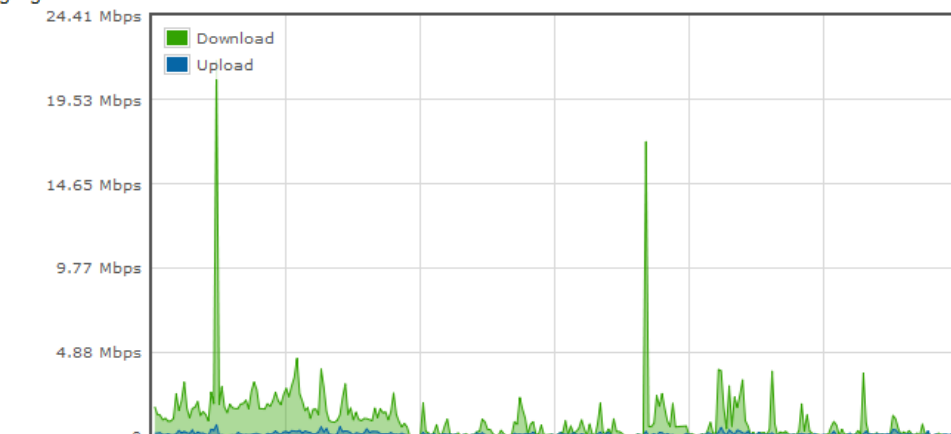

Avg: ↓ 0.99 Mbps ↑ 0.12 Mbps Peak: ↓ 21.78 Mbps ↑ 0.67 Mbps Stacked

	Download	Upload	Total
Overall	61 kbps	75 kbps	136 kbps

28.2 Hourly

This page shows the hourly bandwidth usage for all WAN connections, with the option of viewing each individual connection. Select the desired connection to check from the drop-down menu.

Hourly Usage	
Connection	All WAN
Scale	<input checked="" type="radio"/> MB <input type="radio"/> GB

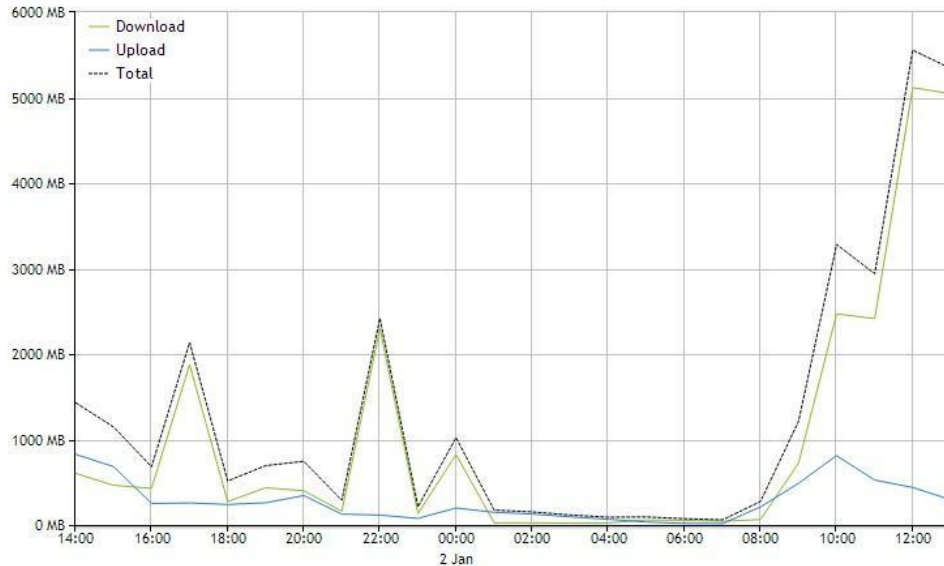

Date	Download	Upload	Total
13:00	5 047 MB	295 MB	5 342 MB
12:00	5 117 MB	439 MB	5 556 MB
11:00	2 414 MB	526 MB	2 940 MB
10:00	2 470 MB	812 MB	3 282 MB
09:00	725 MB	488 MB	1 213 MB
08:00	64 MB	211 MB	275 MB

28.3 Daily

This page shows the daily bandwidth usage for all WAN connections, with the option of viewing each individual connection.

Select the connection to check from the drop-down menu. If you have enabled the **Bandwidth Monitoring** feature, the **Current Billing Cycle** table for that WAN connection will be displayed.

Click on a date to view the client bandwidth usage of that specific date. This feature is not available if you have selected to view the bandwidth usage of only a particular WAN connection. The scale of the graph can be set to display megabytes (**MB**) or gigabytes (**GB**).

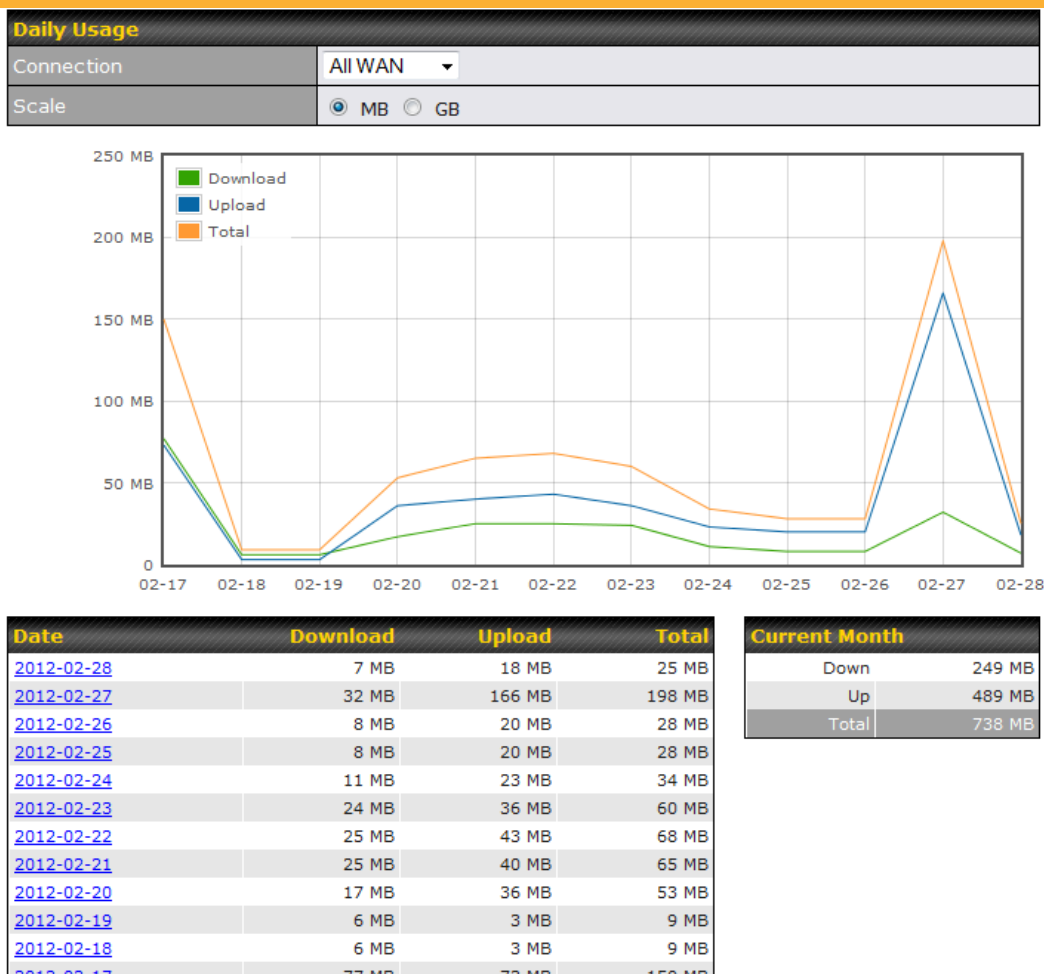

All WAN Daily Bandwidth Usage

28.4 Monthly

This page shows the monthly bandwidth usage for each WAN connection. If you have enabled the **Bandwidth Monitoring** feature, you can check the usage of each particular connection and view the information by **Billing Cycle** or by **Calendar Month**.

Click the first two rows to view the client bandwidth usage in the last two months. This feature is not available if you have chosen to view the bandwidth of an individual WAN connection. The scale of the graph can be set to display megabytes (**MB**) or gigabytes (**GB**).

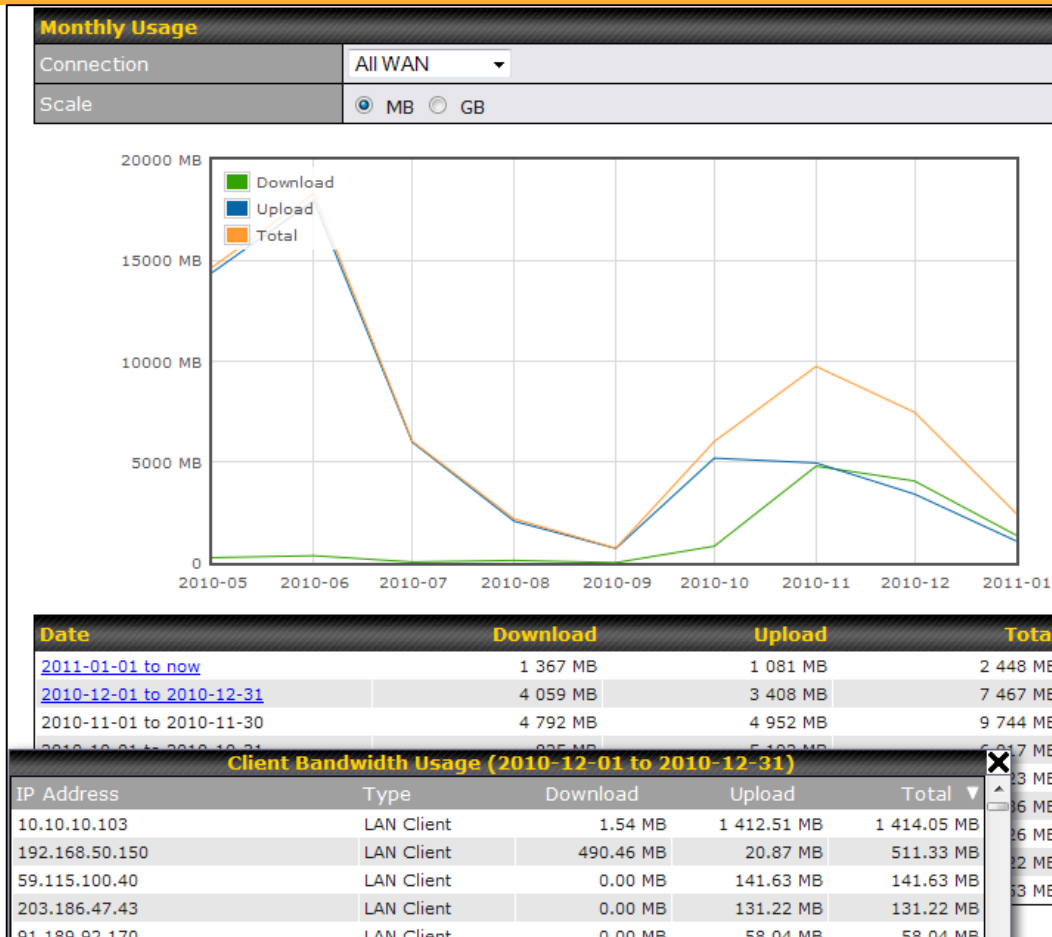

All WAN Monthly Bandwidth Usage

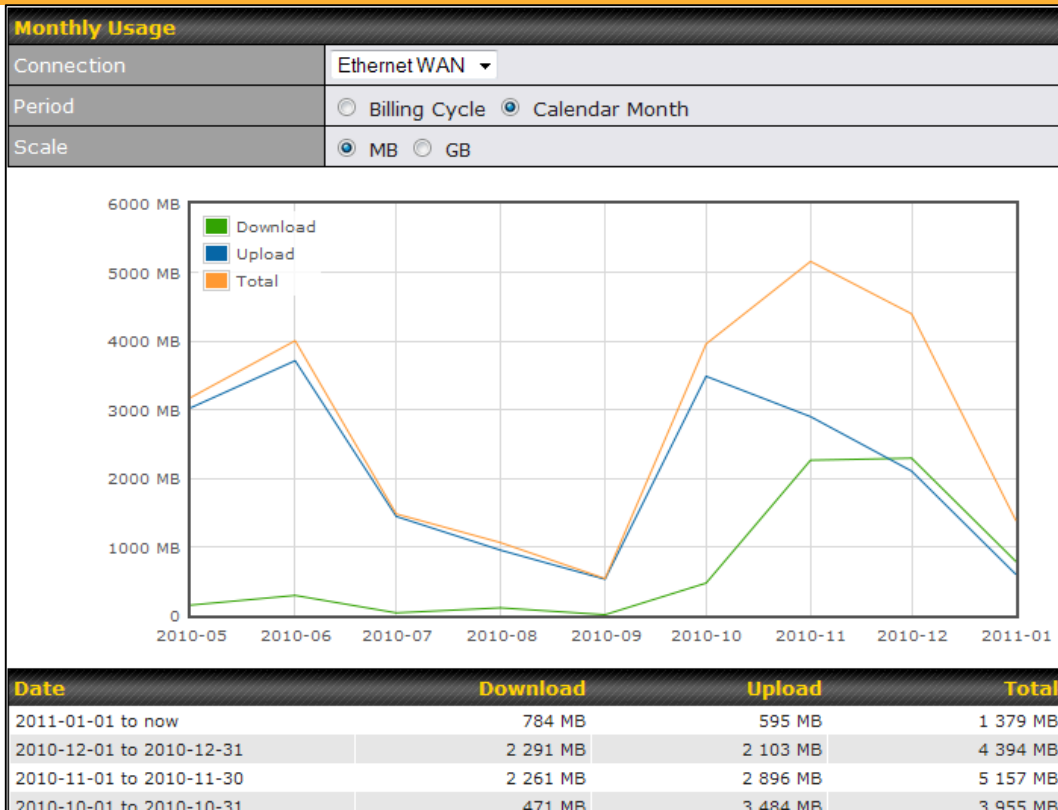

Ethernet WAN Monthly Bandwidth Usage

Tip

By default, the scale of data size is in **MB**. 1GB equals 1024MB.

Appendix A. Restoration of Factory Defaults

To restore the factory default settings on a Pepwave router, follow the steps below:

1. Locate the reset button on the front or back panel of the Pepwave router.
2. With a paper clip, press the reset button and hold it for at least 10 seconds, until the unit reboots itself.

After the Pepwave router finishes rebooting, the factory default settings will be restored.

Important Note

All previous configurations and bandwidth usage data will be lost after restoring factory default settings. Regular backup of configuration settings is strongly recommended.

Appendix B: Declaration

1. **The device supports time division technology**
2. **Federal Communication Commission Interference Statement**

This device complies with Part 15 of the FCC Rules. Operation is subject to the following two conditions: (1) This device may not cause harmful interference, and (2) this device must accept any interference received, including interference that may cause undesired operation.

This equipment has been tested and found to comply with the limits for a Class B digital device, pursuant to Part 15 of the FCC Rules. These limits are designed to provide reasonable protection against harmful interference in a residential installation. This equipment generates, uses and can radiate radio frequency energy and, if not installed and used in accordance with the instructions, may cause harmful interference to radio communications. However, there is no guarantee that interference will not occur in a particular installation. If this equipment does cause harmful interference to radio or television reception, which can be determined by turning the equipment off and on, the user is encouraged to try to correct the interference by one of the following measures:

- Reorient or relocate the receiving antenna.
- Increase the separation between the equipment and receiver.
- Connect the equipment into an outlet on a circuit different from that to which the receiver is connected.
- Consult the dealer or an experienced radio/TV technician for help. FCC Caution: Any changes or modifications not expressly approved by the party responsible for compliance could void the user's authority to operate this equipment.

This transmitter must not be co-located or operating in conjunction with any other antenna or transmitter.

Operations in the 5.15-5.25GHz band are restricted to indoor usage only.

IMPORTANT NOTE

FCC Radiation Exposure Statement (for MAX700/ HD2/ HD2 IP67/ BR1)

This equipment complies with FCC radiation exposure limits set forth for an uncontrolled environment. This equipment should be installed and operated with minimum distance 20cm between the radiator & your body.

FCC Radiation Exposure Statement (for MAX On-The-Go)

This equipment complies with FCC radiation exposure limits set forth for an uncontrolled environment.

1. 20cm minimum when the product is operated alone without co-transmitting with a plug-in 3G USB dongle device.
2. 65cm minimum when the product is operated with a plug-in 3G USB device which has maximum of 7W ERP output power.
3. For co-transmission scenario which is not covered above, please consult the RF technician or device supplier.

This transmitter must not be co-located or operating in conjunction with any other antenna or transmitter.

The availability of some specific channels and/or operational frequency bands are country dependent and are firmware programmed at the factory to match the intended destination.

3. IC Statement for (for MAX BR1 mini)

This device complies with Industry Canada license-exempt RSS standard(s). Operation is subject to the following two conditions: (1) this device may not cause interference, and (2) this device must accept any interference, including interference that may cause undesired operation of the device.

Le présent appareil est conforme aux CNR d'Industrie Canada applicables aux appareils radio exempts de licence. L'exploitation est autorisée aux deux conditions suivantes : (1) l'appareil ne doit pas produire de brouillage, et (2) l'utilisateur de l'appareil doit accepter tout brouillage radioélectrique subi, même si le brouillage est susceptible d'en compromettre le fonctionnement.

To maintain compliance with the RF exposure guidelines, place the unit at least 20cm from nearby persons.

Mise en garde_: Pour assurer la conformité aux directives relatives à l'exposition aux fréquences radio, le jouet doit être placé à au moins 20_cm des personnes à proximité.

4. CE Statement for Pepwave Routers

Europe – EU Declaration of Conformity

This device complies with the essential requirements of the R&TTE Directive 1999/5/EC. The following test methods have been applied in order to prove presumption of conformity with the essential requirements of the R&TTE Directive 1999/5/EC:

- EN 60950-1: 2006 + A11 : 2009+A1 : 2010+ A12: 2011
Safety of Information Technology Equipment

- EN50385 : 2002 / Article 3(1)(a)
Product standard to demonstrate the compliance of radio base stations and fixed terminal stations for wireless telecommunication systems with the basic restrictions or the reference levels related to human exposure to radio frequency electromagnetic fields (110MHz - 40 GHz) - General public

EN 300 328 V1.7.1: 2006
Electromagnetic compatibility and Radio spectrum Matters (ERM); Wideband Transmission systems; Data transmission equipment operating in the 2,4 GHz ISM band and using spread spectrum modulation techniques; Harmonized EN covering essential requirements under article 3.2 of the R&TTE Directive







- EN 301 908-1 V5.2.1: 2011
Electromagnetic compatibility and Radio spectrum Matters (ERM); Base Stations (BS), Repeaters and User Equipment (UE) for IMT-2000 Third-Generation cellular networks; Part 1: Harmonized EN for IMT-2000, introduction and common requirements, covering essential requirements of article 3.2 of the R&TTE Directive

- EN 301 511 V9.0.2: 2003
Global System for Mobile communications (GSM); Harmonized standard for mobile stations in the GSM 900 and DCS 1800 bands covering essential requirements under article 3.2 of the R&TTE directive (1999/5/EC)

- EN 301 489-1 V1.9.2: 2008
Electromagnetic compatibility and Radio Spectrum Matters (ERM); ElectroMagnetic Compatibility (EMC) standard for radio equipment and services; Part 1: Common technical requirements

- EN 301 489-7 V1.3.1: 2005
ElectroMagnetic compatibility and Radio spectrum Matters (ERM); ElectroMagnetic Compatibility (EMC) standard for radio equipment and services; Part 7: Specific conditions for mobile and portable radio and ancillary equipment of digital cellular radio telecommunications systems (GSM and DCS)
- EN 301 489-17 V2.2.1: 2012
Electromagnetic compatibility and Radio spectrum Matters (ERM); ElectroMagnetic Compatibility (EMC) standard for radio equipment and services; Part 17: Specific conditions for 2,4 GHz wideband transmission systems and 5 GHz high performance RLAN equipment
- EN 301 489-24 V1.5.1: 2010
Electromagnetic compatibility and Radio Spectrum Matters (ERM); ElectroMagnetic Compatibility (EMC) standard for radio equipment and services; Part 24: Specific conditions for IMT-2000 CDMA Direct Spread (UTRA) for Mobile and portable (UE) radio and ancillary equipment



 Česky [Czech]	<i>[Jméno výrobce]</i> tímto prohlašuje, že tento <i>[typ zařízení]</i> je ve shodě se základními požadavky a dalšími příslušnými ustanoveními směrnice 1999/5/ES.
 Dansk [Danish]	Undertegnede <i>[fabrikantens navn]</i> erklærer herved, at følgende udstyr <i>[udstyrets typebetegnelse]</i> overholder de væsentlige krav og øvrige relevante krav i direktiv 1999/5/EF.
 Deutsch [German]	Hiermit erkläre <i>[Name des Herstellers]</i> , dass sich das Gerät <i>[Gerätetyp]</i> in Übereinstimmung mit den grundlegenden Anforderungen und den übrigen einschlägigen Bestimmungen der Richtlinie 1999/5/EG befindet.
 Eesti [Estonian]	Käesolevaga kinnitab <i>[tootja nimi = name of manufacturer]</i> seadme <i>[seadme tüüp = type of equipment]</i> vastavust direktiivi 1999/5/EÜ põhinõuetele ja nimetatud direktiivist tulenevatele teistele asjakohastele sätetele.
 English	Hereby, <i>[name of manufacturer]</i> , declares that this <i>[type of equipment]</i> is in compliance with the essential requirements and other relevant provisions of Directive 1999/5/EC.
 Español [Spanish]	Por medio de la presente <i>[nombre del fabricante]</i> declara que el <i>[clase de equipo]</i> cumple con los requisitos esenciales y cualesquiera otras disposiciones aplicables o exigibles de la Directiva 1999/5/CE.
 Ελληνική	ΜΕ ΤΗΝ ΠΑΡΟΥΣΑ <i>[name of manufacturer]</i> ΔΗΛΩΝΕΙ ΟΤΙ <i>[type of equipment]</i>

[Greek]	ΣΥΜΜΟΡΦΩΝΕΤΑΙ ΠΡΟΣ ΤΙΣ ΟΥΣΙΩΔΕΙΣ ΑΠΑΙΤΗΣΕΙΣ ΚΑΙ ΤΙΣ ΛΟΙΠΕΣ ΣΧΕΤΙΚΕΣ ΔΙΑΤΑΞΕΙΣ ΤΗΣ ΟΔΗΓΙΑΣ 1999/5/ΕΚ.
[fr] Français [French]	Par la présente [<i>nom du fabricant</i>] déclare que l'appareil [<i>type d'appareil</i>] est conforme aux exigences essentielles et aux autres dispositions pertinentes de la directive 1999/5/CE.
[it] Italiano [Italian]	Con la presente [<i>nome del costruttore</i>] dichiara che questo [<i>tipo di apparecchio</i>] è conforme ai requisiti essenziali ed alle altre disposizioni pertinenti stabilite dalla direttiva 1999/5/CE.
[lv] Latviski [Latvian]	Ar šo [<i>name of manufacturer / izgatavotāja nosaukums</i>] deklarē, ka [<i>type of equipment / iekārtas tips</i>] atbilst Direktīvas 1999/5/EK būtiskajām prasībām un citiem ar to saistītajiem noteikumiem.
[lt] Lietuvių [Lithuanian]	Šiuo [<i>manufacturer name</i>] deklaruoja, kad šis [<i>equipment type</i>] atitinka esminius reikalavimus ir kitas 1999/5/EB Direktyvos nuostatas.
[nl] Nederlands [Dutch]	Hierbij verklaart [<i>naam van de fabrikant</i>] dat het toestel [<i>type van toestel</i>] in overeenstemming is met de essentiële eisen en de andere relevante bepalingen van richtlijn 1999/5/EG.
[mt] Malti [Maltese]	Hawnhekk, [<i>isem tal-manifattur</i>], jiddikjara li dan [<i>il-mudel tal-prodott</i>] jikkonforma mal-ħtiġijiet essenzjali u ma provvedimenti oħrajn rilevanti li hemm fid-Dirrettiva 1999/5/EC.
[hu] Magyar [Hungarian]	Alulírott, [<i>gyártó neve</i>] nyilatkozom, hogy a [<i>... típus</i>]megfelel a vonatkozó alapvető követelményeknek és az 1999/5/EC irányelv egyéb előírásainak.
[pl] Polski [Polish]	Niniejszym [<i>nazwa producenta</i>] oświadczam, że [<i>nazwa wyrobu</i>] jest zgodny z zasadniczymi wymogami oraz pozostałymi stosownymi postanowieniami Dyrektywy 1999/5/EC.
[pt] Português [Portuguese]	[<i>Nome do fabricante</i>] declara que este [<i>tipo de equipamento</i>] está conforme com os requisitos essenciais e outras disposições da Directiva 1999/5/CE.
[sl] Slovensko [Slovenian]	[<i>Ime proizvajalca</i>] izjavlja, da je ta [<i>tip opreme</i>] v skladu z bistvenimi zahtevami in ostalimi relevantnimi določili direktive 1999/5/ES.
[sk] Slovensky [Slovak]	[<i>Meno výrobcu</i>] týmto vyhlasuje, že [<i>typ zariadenia</i>]spĺňa základné požiadavky a všetky príslušné ustanovenia Smernice 1999/5/ES.
[fi] Suomi [Finnish]	[<i>Valmistaja = manufacturer</i>] vakuuttaa täten että [<i>type of equipment = laitteen tyyppimerkintä</i>] tyyppinen laite on direktiivin 1999/5/EY oleellisten vaatimusten ja sitä koskevien direktiivin muiden ehtojen mukainen.
[sv] Svenska [Swedish]	Härmed intygar [<i>företag</i>] att denna [<i>utrustningstyp</i>] står i överensstämmelse med de väsentliga egenskapskrav och övriga relevanta bestämmelser som framgår av direktiv 1999/5/EG.

4. NCC for Pepwave Routers

For MAX Transit

WLAN

[警語]

「電磁波曝露量 MPE 標準值 1mW/cm²，本產品使用時建議應距離人體 24 cm」

[警語內容]

(1) 電磁波警語標示：「減少電磁波影響，請妥適使用」。標示方式：必須標示於設備本體適當位置及設備外包裝及使用說明書上。

低功率電波輻射性電機管理辦法

第十二條 經型式認證合格之低功率射頻電機，非經許可，公司、商號或使用者均不得擅自變更頻率、加大功率或變更原設計之特性及功能。

第十四條 低功率射頻電機之使用不得影響飛航安全及干擾合法通信；經發現有干擾現象時，應立即停用，並改善至無干擾時方得繼續使用。前項合法通信，指依電信法規定作業之無線電通信。低功率射頻電機須忍受合法通信或工業、科學及醫療用電波輻射性電機設備之干擾。

本行動寬頻設備的行動寬頻頻段(LTE900/LTE1800)

警告使用者:

此為甲類資訊技術設備，於居住環境中使用時，可能會造成射頻擾動，在此種情況下，使用者會被要求採取某些適當的對策。